

baridi

Baridi 46" Wall Mounting Electric Fireplace, LED Flame Effects



Model No's DH112, DH113

Thank you for purchasing a Dellonda product. Manufactured to a high standard, this product will, if used according to these instructions, and properly maintained, give you years of trouble free performance.

Important Information

Please read these instructions carefully. Note the safe operational requirements, warnings & cautions. Use the product correctly and with care for the purpose for which it is intended. Failure to do so may cause damage and/or personal injury and will invalidate the warranty. Keep these instructions safe for future use.



Refer to
instruction
manual



DO NOT cover



Warning:
hot
surface

Specification

- Electrical Class: Class 1
- Heated Area: 20-25m²
- Weight: **DH112**: 24kg, **DH113**: 22kg
- Heat Settings: 2
- Plug Type: 3-Pin **BS**
- Power Cable Length: 1.5m
- Dimensions (W X D X H): 1320 x 210 x 580mm
- Rated Power: 2 settings 1000/2000W
- Supply: 230V~50Hz

Safety Instructions

- **ELECTRICAL SAFETY**
- **WARNING!** It is the user's responsibility to check the following:
 - Check all electrical equipment and appliances to ensure that they are safe before using.
 - Inspect power supply leads, plugs and all electrical connections for wear and damage.
 - Ensure that the insulation on all cables and on the appliance is safe before connecting it to the power supply.
- **DO NOT** use worn or damaged cables, plugs or connectors.
- Ensure that any faulty item is repaired or is replaced immediately by a qualified electrician.
- If the cable or plug is damaged during use, switch off the electricity supply and remove from use. If the supply cord is damaged, it must be replaced by the manufacturer, its service agent or similarly qualified persons in order to avoid a hazard.
- Dellonda recommend that an **RCD** (Residual Current Device) is used with all electrical products.
- Important: Ensure that the voltage rating on the appliance suits the power supply to be used and that the plug is fitted with the correct fuse.
- **DO NOT** pull or carry the appliance by the power cable.
- **DO NOT** pull the plug from the socket by the cable.
- The heater must not be located under an electrical socket; the socket must always be accessible in order to disconnect the heater from the electrical supply for maintenance and cleaning.
- **GENERAL SAFETY**
- **IMPORTANT:** Read all instructions and warnings carefully before starting installation. Failure to follow these instructions may result in a possible electric shock or fire hazard and will void the warranty.
- **WARNING!** In order to avoid overheating, **DO NOT** cover the heater.
- Children from age 8 years and above, persons with reduced physical, sensory, or mental capabilities those with lack of experience and knowledge can use the appliance, if they have been given supervision or instruction concerning use of the appliance in a safe way to understand the hazards involved.
- Children shall **NOT** play with the appliance.
- Cleaning and user maintenance on the appliance shall not be made by children without supervision.
- Children of less than 3 years should be kept away unless continuously supervised. Children aged from 3 years and less than 8 years shall only switch on/off the appliance provided that it has been placed or installed in its intended normal operating position and they have been given supervision or instruction concerning use of the appliance in a safe way and understand the hazards involved. Children aged from 3 years and less than 8 years shall not plug in, regulate, and clean the appliance or perform user maintenance.
- The removal of the plug has to be such that an operator can check from any of the points to which he has access that the plug remains removed.
- **CAUTION!** Some parts of this product can become very hot and cause burns. Particular attention has to be given where children and vulnerable people are present.
- **DO NOT** use this heater with a programmer, timer, separate remote-control system or any other device that switches the heater on automatically, since a fire risk exists if the heater is covered or positioned incorrectly.
- To avoid burns, do not let bare skin touch any hot surfaces.
- **WARNING!** The heater must not be used if the glass panels are damaged.
- **DO NOT** attempt to repair, disassemble or modify the appliance. This unit contains no user-serviceable parts.
- Always unplug or disconnect the appliance from the mains power supply when not in use, or when moving or cleaning it.
- Keep the heater clean. **DO NOT** allow any object to enter the ventilation or exhaust opening as this may cause electric shock, fire, or damage to the heater.
- **DO NOT** use the appliance for anything other than its intended use. It is designed for domestic indoor use only.
- There may be a trace of odour during the first few minutes of initial use, or after a period of storage. This is normal and will quickly disappear.
- Avoid the use of an extension cord, as the cord may overheat and cause a risk of fire.
- This fireplace is hot when in use. Keep combustible materials, such as furniture, pillows, bedding, papers, clothes and curtains at least 1 metre from the front and sides of this appliance.
- This appliance is designed for indoor use only and is not intended for use in bathrooms, laundry areas and similar indoor locations. Never locate this appliance where it may become exposed to water.
- **DO NOT** place this fire directly onto a carpeted surface to avoid discolouration due to the heat.
- **DO NOT** run the cord under carpeting. **DO NOT** cover the cord with throw rugs, runners or the like.

- Ensure the cord is kept away from traffic areas, and kept in a position which would not present a trip hazard.
- To disconnect this appliance, press the On/Off button to turn off, then remove the plug from the outlet.
- This appliance has hot and arcing or sparking parts inside. **DO NOT** use it in areas where petrol, paint, or any flammable liquids are used or stored.
- This appliance should not be used as a drying rack for clothing, nor should Christmas decorations be hung on or near it.
- Clean the fire regularly to prevent the build-up of hairs, dust or lint around the fire, as this may cause the outlet to become blocked.
- **DO NOT** use aerosols or steam cleaners on or around the fire.

Manual Handling

- The heater must not be moved while in use. Please allow a suitable amount of time for the unit to cool before attempting to move it.
- Two people should lift the heater.

Contents

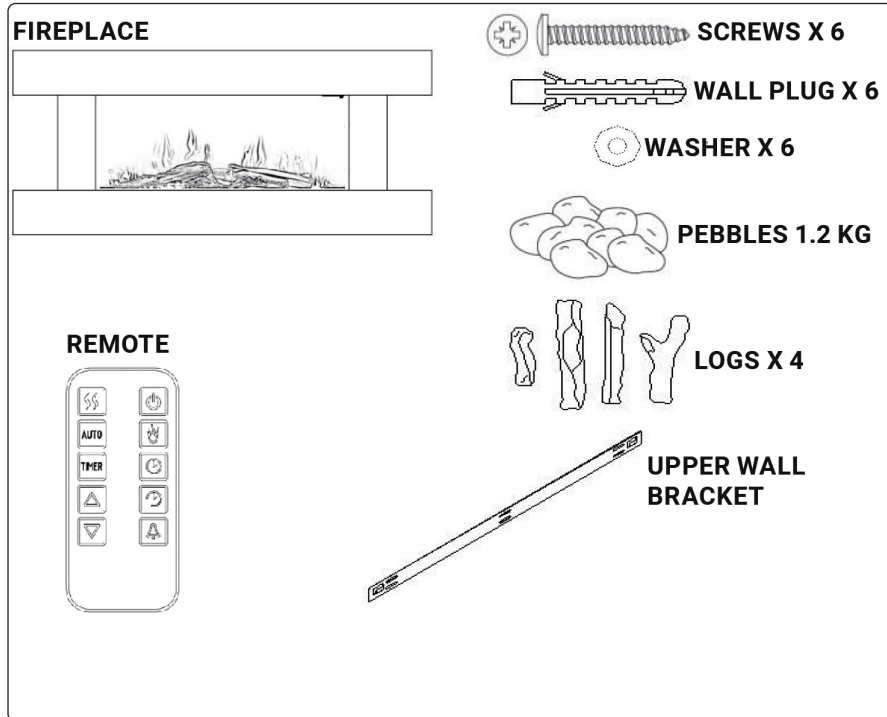

Dimensions

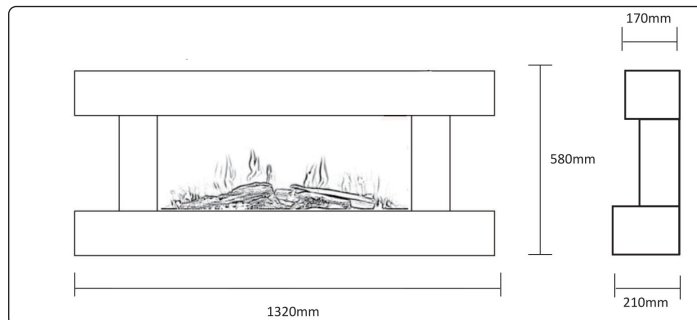

Installation

- This product is designed to be mounted flat to the wall.
- Before installation please ensure that the floor and wall are flat, and there is nothing that would prevent the fire fitting flush.
- 1. The fire is designed to be permanently fixed to a wall with a minimum distance of 300mm between the base of the fire and the floor.
- A distance of 600mm is recommended for the optimum height on the wall.
- 2. The upper bracket should be placed against the wall 490mm above the planned position of the base of the fire.
- 3. While ensuring that the bracket is level (using a spirit level) mark the position of the six screw holes in the wall.
- 4. Put the bracket to one side, drill the holes marked in step 3 with an 8mm drill bit to a depth of around 35mm.
- 5. Clean any dust and debris from drilling, and insert a wall plug into each hole, ensuring they are flush with the surface of the wall.
- 6. Hold the bracket in position and attach to the wall using 6 screws.
- 7. Two people should carefully lift the fire into position, ensuring the top edge of the fire engages with the bracket.
- 8. Spread the supplied pebbles/branches (model dependant) in position on the light at the front of the unit.

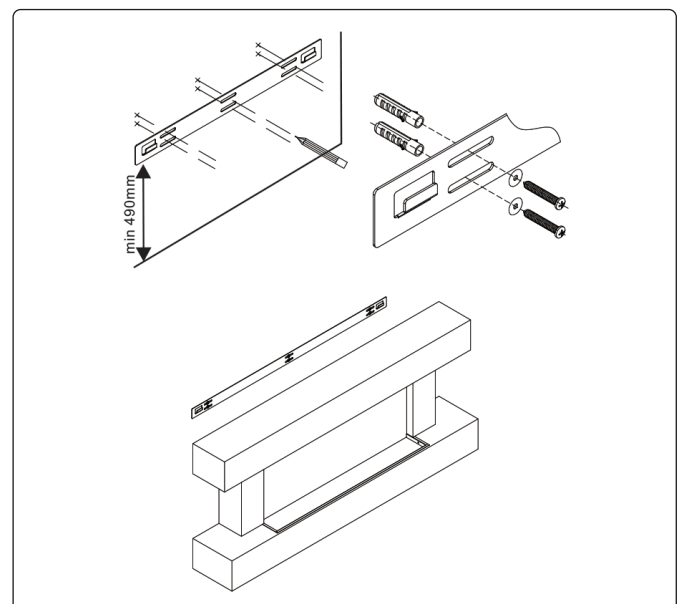





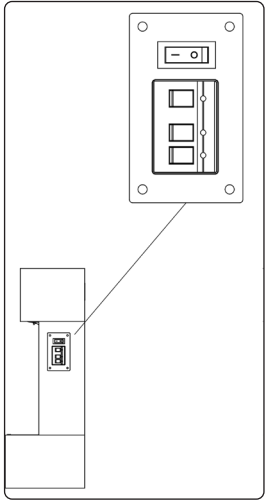
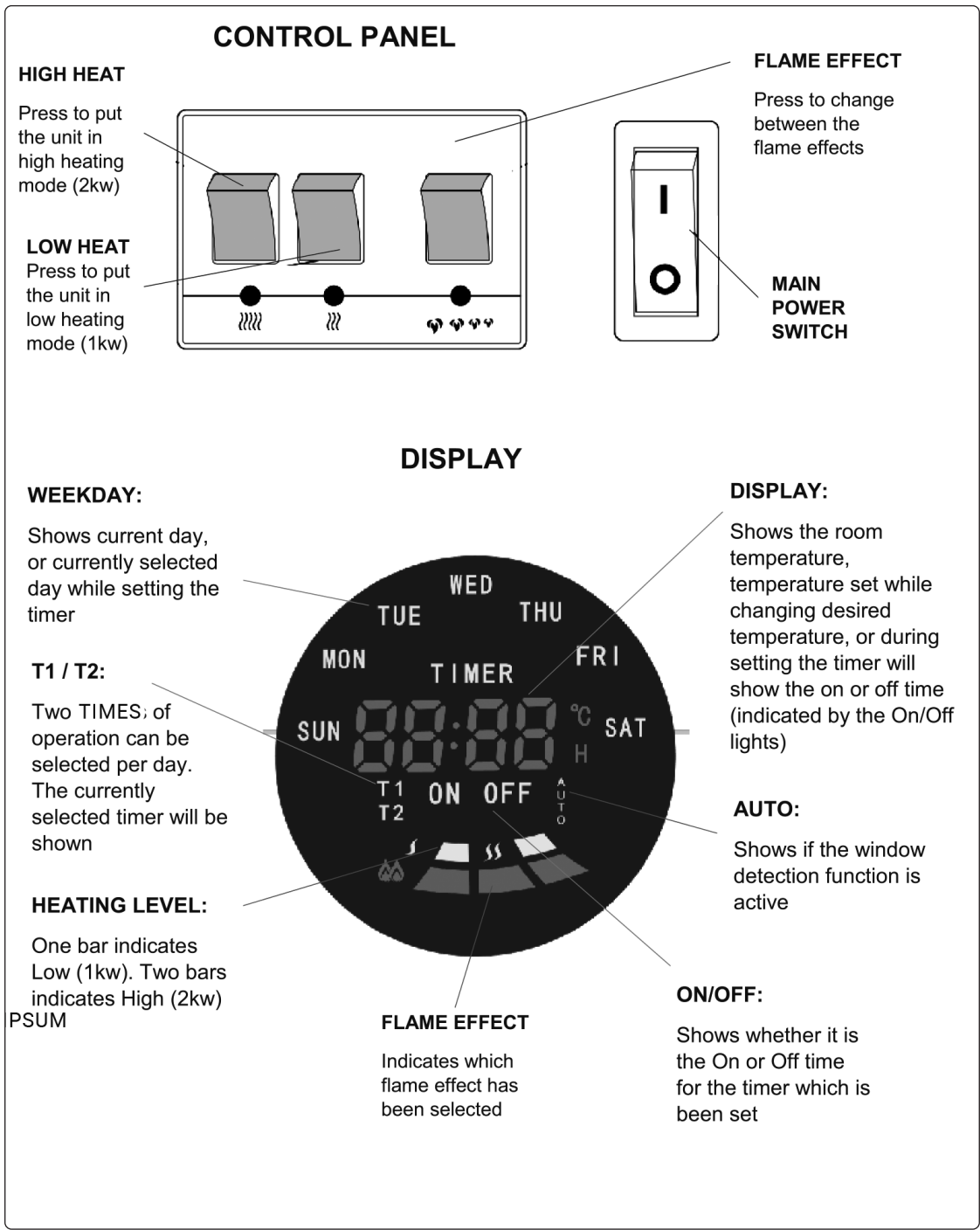



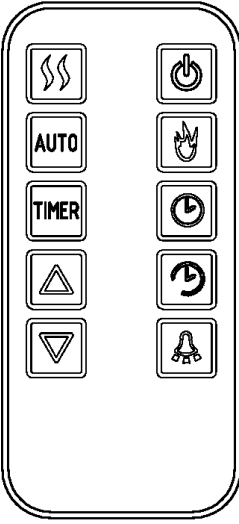

- **NOTE:**
- The wall plugs supplied are designed for solid walls, and so depending on the type of wall, a different type of plug may be required (but not included).
- Before drilling into the wall, you must ensure that there is no pipework or wiring behind the wall which may be damaged during installation.
- The fire must be installed by a competent person, if in any doubt about installation, the suitability of the wall, or wall plugs supplied, professional advice should be sought.

Operation



REMOTE CONTROL

Power Button		Press to turn the appliance On and Off.	
Flame Button		Press to cycle between the three flame effects.	
Arrow Buttons	 	Use to change the desired room temperature. The temperature currently selected will be displayed.	
Heating Level Button		Press to change between the available heating levels.	
Downlight		Press to turn the downlights On / Off.	
Timer On / Off		Press to turn the timer On/Off.	
Clock		<p>Before using the weekly timer, the clock must be set. To do this: Press the CLOCK button, then use the arrow buttons to select the day. Press CLOCK again, then use the arrow buttons to select the hour value (24 hour format) Press CLOCK again, then use the arrow buttons to select the minute value.</p>	
Week Timer		<p>Your fire includes a 7 day timer, which allows you to set two periods of operation per day. The fire will operate with the previously used settings for the heating level, desired temperature, and flame colour. To set the timer press the TIMER button. The unit will display the day, period, and if you are setting the On or Off time. For each Period both the On and Off times must be set. For each Period: 1. Set the On hour value using the arrow buttons, press TIMER to confirm 2. Set the On minute value using the arrow buttons, press TIMER to confirm 3. Set the Off hour value using the arrow buttons, press TIMER to confirm 4. Set the Off minute value using the arrow buttons, press TIMER to confirm The fire will then move onto the next period / first period of following day, allowing this to be programmed in the same way. The days and periods can be scrolled through by repeatedly pressing TIMER. To clear an operational period set the ON and OFF times to the same value.</p>	
Open Window Detection		<p>Your fire includes "Open Window Detection" which will stop the heating function after a period of time if the room temperature is not increasing, on the assumption that there is an open door or window. This is designed to save energy and can be turned on and off using the AUTO button. When the function has been activated, AUTO will flash on the screen.</p>	

Maintenance

- **WARNING!** Before cleaning the appliance, the power supply should be disconnected and the unit should be allowed to cool.
- Dust can be removed by lightly wiping the glass surface with clean, lint free cloth or paper towel.
- To remove fingerprints or other marks, use a damp cloth with a good quality household glass cleaner. The front glass panel should be completely dried and cooled down, before reusing the heater.
- **CAUTION:**
- **DO NOT** use abrasive cleaner on the glass panel.
- **DO NOT** spray liquids directly onto any surface of the unit.
- **DO NOT** clean the glass on the inside of the unit as this may cause damage to the surface.
- **REPLACING THE BATTERIES IN THE REMOTE CONTROL**
- The remote control takes a CR2025 battery. If the remote becomes unresponsive, change the battery with a new battery, as shown in the image below.

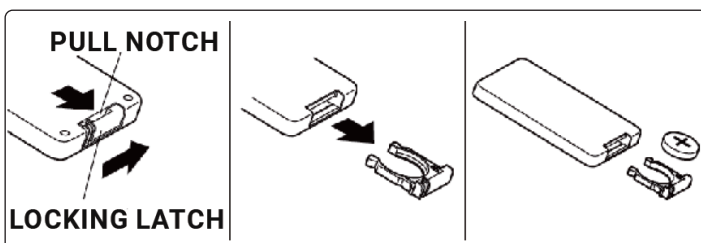

Problem	Cause	Solution
Fire has stopped working.	The fire has overheated and the thermal safety device has activated or a circuit breaker has tripped.	Check there is power to the socket where the fire is connected, check the fuse in the plug, check the main power switch on the unit is turned on and leave for 10 minutes in case of thermal cut-out.
Flame is not moving.	Flame motor defective.	Contact Dellonda.



Environment Protection, Waste Electrical and Waste Electronic Equipment Regulations (WEEE)



Recycle unwanted packaging materials. When this product is no longer required, or has reached the end of its useful life, please dispose of in an environmentally friendly way. Drain any fluids (if applicable) into approved containers, in accordance with local waste regulations. It is our policy to continually improve products and we reserve the right to alter data, specifications and parts without prior notice. No liability is accepted for incorrect use of this product. Guarantee is 12 months from purchase date, proof of which is required for any claim.



BATTERY REMOVAL

Under the Waste Batteries and Accumulators Regulations 2009, Dellonda Ltd are required to inform potential purchasers of products containing batteries (as defined within these regulations), that they are registered with Valpak's registered compliance scheme. Dellonda Ltd Batteries Producer Registration Number (BPRN) is BPRN00705. Batteries should be removed from remote control and disposed of according to local waste regulations.

Dellonda Limited, Sole UK Distributor of Baridi

Kempson Way, Suffolk Business Park, Bury St Edmunds, Suffolk. IP32 7AR



01284 757575



support@dellonda.co.uk



www.dellonda.co.uk



Information requirements for electric local space heaters

Model identifier(s): DH112 v1 DH113 v1					
Item	Symbol	Value	Unit	Item	Unit
Heat output				Type of heat input, for electric storage local space heaters only (select one)	
Nominal heat output	P_{nom}	2.0	kW	Manual heat charge control, with integrated thermostat	Yes No <input checked="" type="checkbox"/>
Minimum heat output (indicative)* * Enter figure or NA	P_{min}	1.0	kW	Manual heat charge control with room and/or outdoor temperature feedback	Yes No <input checked="" type="checkbox"/>
Maximum continuous heat output	$P_{max,c}$	1.9	kW	Electronic heat charge control with room and/or outdoor temperature feedback	Yes No <input checked="" type="checkbox"/>
				Fan assisted heat output	Yes No <input checked="" type="checkbox"/>
Auxiliary electricity consumption				Type of heat output/room temperature control (select one)	
At nominal heat output	eI_{max}	1.898	kW	Single stage heat output and no room temperature control	Yes No <input checked="" type="checkbox"/>
At minimum heat output	eI_{min}	0.990	kW	Two or more manual stages, no room temperature control	Yes No <input checked="" type="checkbox"/>
In standby mode	eI_{SB}	0.0043	kW	With mechanic thermostat room temperature control	Yes No <input checked="" type="checkbox"/>
				With electronic room temperature control	Yes No <input checked="" type="checkbox"/>
				Electronic room temperature control plus day timer	Yes No <input checked="" type="checkbox"/>
				Electronic room temperature control plus week timer	Yes <input checked="" type="checkbox"/> No
				Other control options (multiple selections possible)	
				Room temperature control, with presence detection	Yes No <input checked="" type="checkbox"/>
				Room temperature control, with open window detection	Yes <input checked="" type="checkbox"/> No
				With distance control option	Yes No <input checked="" type="checkbox"/>
				With adaptive start control	Yes No <input checked="" type="checkbox"/>
				With working time limitation	Yes <input checked="" type="checkbox"/> No
				With black bulb sensor	Yes No <input checked="" type="checkbox"/>
Contact details: Dellonda Ltd, Farney Street, Carrickmacross, Co. Monaghan, A81 PK68 Ireland www.dellonda.co.uk					
v1 ERP Table 2					