



6/12/24V BATTERY STARTER/CHARGER

MODEL NO: **SUPERSTART550E, SUPERSTART750E,
SUPERSTART950E**

Thank you for purchasing a Sealey product. Manufactured to a high standard, this product will, if used according to these instructions, and properly maintained, give you years of trouble free performance.

IMPORTANT: PLEASE READ THESE INSTRUCTIONS CAREFULLY. NOTE THE SAFE OPERATIONAL REQUIREMENTS, WARNINGS & CAUTIONS. USE THE PRODUCT CORRECTLY AND WITH CARE FOR THE PURPOSE FOR WHICH IT IS INTENDED. FAILURE TO DO SO MAY CAUSE DAMAGE AND/OR PERSONAL INJURY AND WILL INVALIDATE THE WARRANTY. KEEP THESE INSTRUCTIONS SAFE FOR FUTURE USE.



Refer to instructions



Warning



Wear eye protection



Warning corrosive substance



Wear protective gloves



Electrical shock hazard



Keep in dry area protect from rain

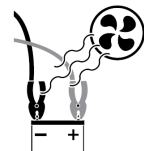

Use in well ventilated areas



Keep away from sources of ignition

1. SAFETY

IMPORTANT: To reduce the risk of a battery explosion, follow these instructions and those published by the battery manufacturer and the manufacturer of any equipment you intend to use in the vicinity of the battery. Remember to review warning marks on all products and on engines. Modern vehicles contain extensive electronic systems. Check with the vehicle manufacturer for any specific instructions regarding the use of this type of equipment on each vehicle. No liability will be accepted for damage/injury where this product is not used in accordance with all instructions.

1.1. SAFETY INSTRUCTIONS

- ✓ Read instructions carefully before using this product.
- ✓ The product is only to be used to start 12V and 24V vehicles. It may lead to damage or be dangerous if used for other different voltage rated machines.
- ✓ This product is not intended to be used as a replacement vehicle battery.
- ✓ Ensure the vehicle's battery terminals are clean and battery clamps are connected properly before jump starting the vehicle. Dirty or corroded on battery terminals may effect the starting performance.
- * **DO NOT** crank the engine for more than 3 seconds at a time. The jump start feature is designed for short term operation only. Operating the jump start feature for more than 3 seconds may cause damage to the unit. Allow the jump starter to cool down for at least 2 minutes after each cranking.
- ✓ Remove the battery clamps from the vehicle battery immediately after the engine has started.
- ✓ Wear safety eye protection and protective clothing. Avoid touching eyes while working with a battery.
- ✓ Wash immediately with soap and water if battery acid contacts skin or clothing. If acid enters eye, flush eye immediately with cool, clean running water for at least 15 minutes and seek immediate medical attention.
- ✓ If the internal battery is leaking do not use and have battery replaced immediately. Isolate the spillage and clean appropriately.
- **WARNING!:** Battery acid can cause skin damage/burns, respiratory issues, eye damage and throat irritation so please ensure all precautions have taken place.
- ✓ Remove personal metallic items such as rings, bracelets, necklaces and watches.
- ✓ Keep the unit in good working order and condition. Replace damaged parts immediately.
- ✓ Use only recommended parts. To use unapproved parts may be dangerous and will invalidate your warranty.
- ✓ The unit must only be opened and checked by qualified service personnel. **DO NOT** disassemble the unit for any reason.
- * **DO NOT** modify the product.
- ✓ Keep children and unauthorised persons away from the work area.
- ✓ Keep work area clean and tidy and free from unrelated materials. Ensure that there is adequate lighting.
- ✓ If the unit receives a sharp knock or blow, it must be checked by a qualified service agent before being used.
- ✓ Children from age 8 years and above, persons with reduced physical, sensory, or mental capabilities those with lack of experience and knowledge can use the appliance, if they have been given supervision or instruction concerning use of the appliance in a safe way to understand the hazards involved.
- * Children shall **NOT** play with the appliance
- ✓ Cleaning and user maintenance on the appliance shall not be made by children without supervision.
- ✓ The appliance shall be disconnected from its power source during service and when replacing parts and, if that the removal of the plug is foreseen, it shall be clearly indicated that the removal of the plug has to be such that an operator can check from any of the points to which he has access that the plug remains removed.
- * **DO NOT** smoke or allow a spark, or flame in the vicinity of the battery or engine.
- * **DO NOT** drop any metal item onto the battery as it may spark or short circuit the battery, which could cause an explosion.
- * **DO NOT** use unit to recharge dry cell batteries that are commonly used with home appliances.
- * **DO NOT** charge or boost a frozen battery.
- * **DO NOT** use attachments other than those recommended.
- * **DO NOT** pull or carry the unit by its cable
- * **DO NOT** pull the Superstart by negative or positive clamps.
- * **DO NOT** operate in vicinity of flammable liquids, dusts or gases.
- * **DO NOT** recharge the unit with a charger/cables that are damaged. Replace immediately. Only use the correct, supplied charger to recharge the unit.
- * **DO NOT** use this product to perform a task for which it is not designed.
- * **DO NOT** store the unit in damp or wet locations or where the temperature may exceed 50°C.

- x **DO NOT** submerge the unit in water.
 - x **DO NOT** use whilst under the influence of drugs, alcohol or intoxicating medication.
 - x **DO NOT** leave the unit in a totally discharged state for an extended period of time as this may result in permanent damage.
 - x **DO NOT** cross-connect the power leads from the jump starter to the battery. Ensure that positive is to positive and negative is to negative.
 - ✓ Ensure that the unit is fully charged before storage. Keep the unit fully charged on a regular basis.
- 1.2. ELECTRICAL SAFETY**
- **WARNING!** It is the user's responsibility to check the following:
 - ✓ Check all electrical equipment/appliances to ensure they are safe before using. Inspect power supply leads, plugs and all electrical connections for wear and damage. Sealey recommend that an RCD (Residual Current Device) is used with all electrical products. **Electrical safety information.** It is important that the following information is read and understood:
 - ✓ Ensure that the insulation on all cables and on the appliance is safe before connecting it to the power supply.
 - ✓ Regularly inspect power supply cables and plugs for wear or damage and check all connections to ensure that they are secure. **Important:** Ensure that the voltage rating on the appliance suits the power supply to be used and that the plug is fitted with the correct fuse.
 - x **DO NOT** pull or carry the appliance by the power cable.
 - x **DO NOT** pull the plug from the socket by the cable.
 - x **DO NOT** use worn or damaged cables, plugs or connectors. Ensure that any faulty item is repaired or is replaced immediately by a qualified electrician.
 - ✓ If the cable or plug is damaged during use, switch off the electricity supply and remove from use.
 - ✓ **Ensure that repairs are carried out by a qualified electrician.**
 - ✓ Ensure that the insulation on all cables and the product itself is safe before connecting to the mains power supply.
 - ✓ Ensure that cables are always protected against short circuit and overload.
- 1.3. PERSONAL SAFETY**
- x **DO NOT** place the charger in the engine compartment or near moving parts or near the battery; place as far away from them as DC cable permits. Never place a charger directly above a battery being charged; gases or fluids from battery will corrode and damage charger.
 - x **DO NOT** cover the charger while charging.
 - x **DO NOT** expose to rain or wet conditions.
 - ✓ Connect and disconnect mains supply after connecting the positive and negative leads to the battery.
 - x **DO NOT** use accessories that are not recommended or sold by the manufacturer as this may cause a risk of fire or electric shock/injury to its operator.
 - x **DO NOT** overcharge batteries by selecting the wrong charge mode.
 - ✓ Operate with caution if the charger has received direct hit of force or been dropped. Have it checked and repaired if damaged. Any repair must be carried out by the manufacturer or an authorised repair agent in order to avoid danger.
- 1.3.1. GROUNDING AND AC POWER CORD CONNECTIONS**
- 1.3.2. This battery charger is for use on a 230 volt supply. The plug must be plugged into an outlet that is properly installed and grounded in accordance with electrical regulations. **DO NOT** use with an ungrounded system. The use of an adapter plug would be deemed to be unsafe.

2. INTRODUCTION

Suitable for charging 6V, 12V and 24V electrical systems and jump starting 12/24V Vehicles. Fully electronic, microprocessor-controlled charger with up to ten analysis and charge phases, including trickle/maintenance. Suitable for charging VRLA, GEL, AGM/EFB, Leisure and Lithium batteries (12V only). Featuring reverse polarity, short circuit, overcharge, overheat and overcurrent protection systems. BSU mode provides support for the battery during prolonged electronic diagnostic checks. Also features an alternator check and dedicated repair function.

3. SPECIFICATION

Model No:	SUPERSTART550E	SUPERSTART750E	SUPERSTART950E
Battery Range:	6V - 15-550Ah 12V - 15 - 600Ah 24V - 15-550Ah	6V - 15-550Ah 12V - 15-750Ah 24V - 15-550Ah	6V - 15 -550Ah 12V - 15- 750Ah 24V - 15- 550Ah
Battery Support/DC Supply Mode:	30A	45A	45A
Cable & Clamp Length:	1.8m	1.8m	1.8m
Charging Rates:	6V - 5/10/30A 12V - 10/30/50A 24V - 10/30/50A	6V - 5/10/45A 12V - 10/45/70A 24V - 10A/45A/70A	6V - 5/10/45A 12V - 10/40/80A 24V - 10A/40A/80A
Max Size Battery (Ah) full charge in 12hrs:	12V 600Ah	12V 750Ah	12V - 750AH
Nett Weight:	45kg	45kg	45kg
Plug Type:	Bare Wire	Bare Wire	Bare Wire
Power Supply Cable Length:	1.8m	1.8m	1.8m
Start Peak:	N/A	750A	950A
Supply:	230V	230V	230V
Zero Voltage Charging:	N/A	N/A	N/A

4. ASSEMBLY

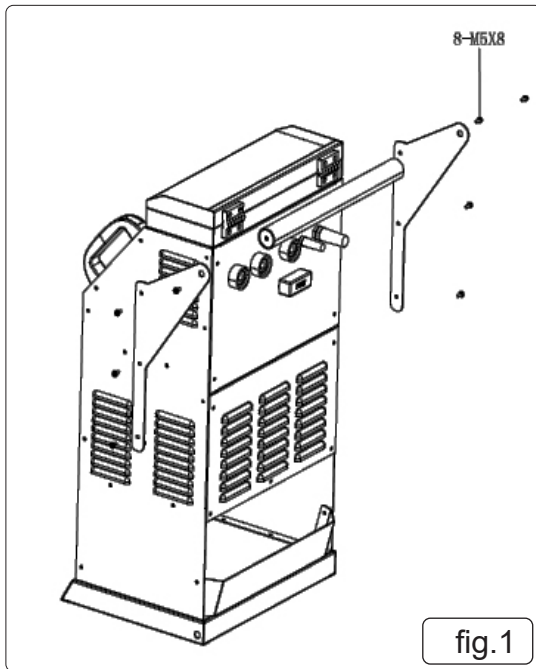

fig.1

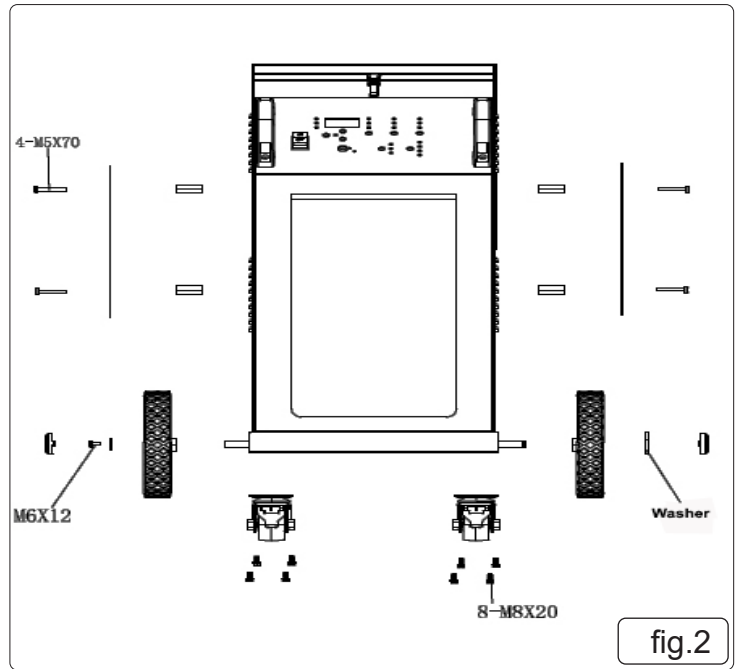
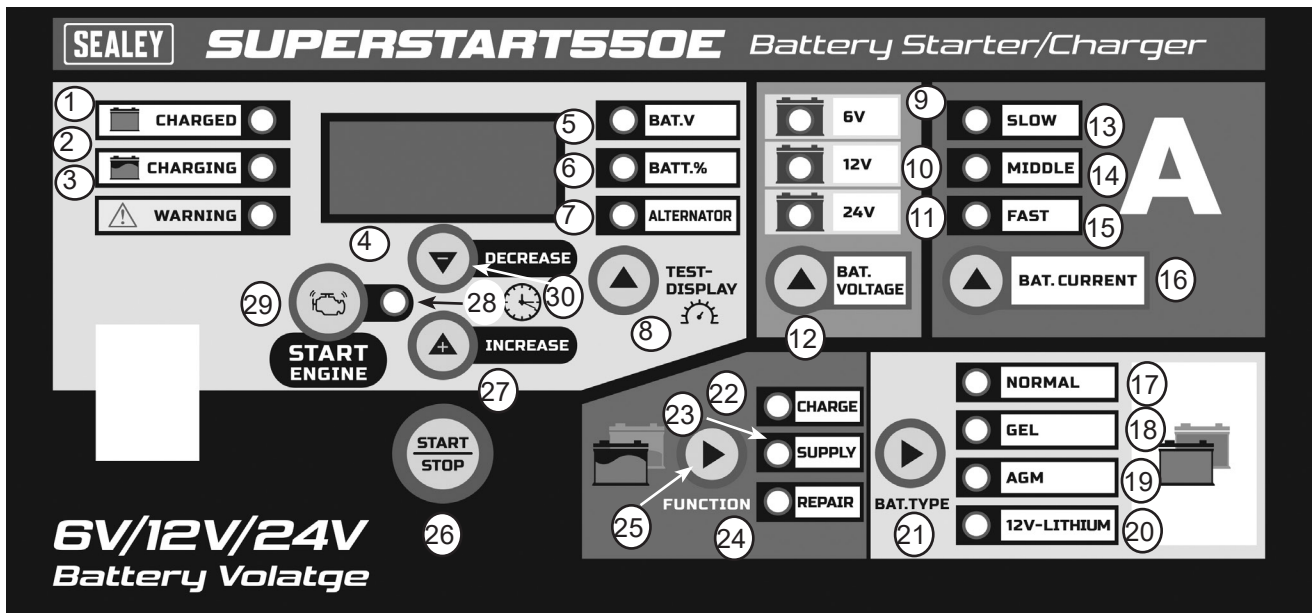

fig.2

5. OPERATION

Item	Description	Item	Description
1	Charged Led Indicator	16	Battery current Button
2	Charging Led Indicator	17	Normal Led Indicator
3	Warning Led Indicator	18	Gel Led Indicator
4	Digital Display	19	Agm Led Indicator
5	Voltage Led Indicator	20	12V-Lithium Indicator
6	Battery % Led Indicator	21	Battery Type Button
7	Alternator % Led Indicator	22	Charge Led Indicator
8	Test Button	23	Supply Led Indicator
9	6V Led Indicator	24	Repair Led Indicator
10	12V Led Indicator	25	Function Button
11	24V Led Indicator	26	Start/Stop Button
12	Battery Voltage Button	27	Increase Button
13	Slow Led Indicator	28	Engine Start Indicator
14	Middle Led Indicator	29	Engine Start Button
15	Fast Led Indicator	30	Decrease Button





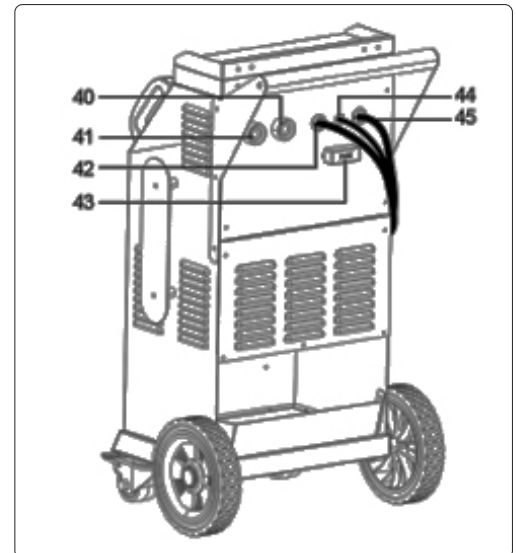
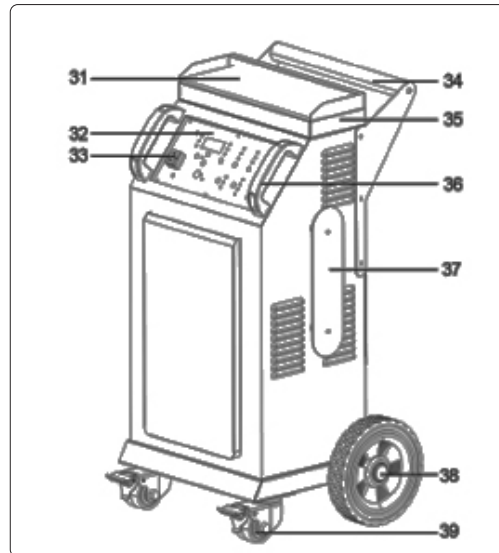

Item	Description
31	Setting Table
32	Plastic Panel
33	Switch Button
34	Iron Handle
35	Storage Box
36	Plastic Handle
37	Winding Support
38	Wheel
39	Caster wheel
40	24V quick plug
41	6V/12V quick plug
42	Negative line
43	Fuse
44	Hand-held starter cable
45	Power cord



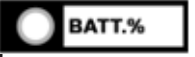

5.1. DISPLAY MESSAGES

5.1.1. Start up – After display screen and all LEDs illuminate for 0.5 second, battery voltage shows.



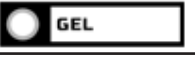
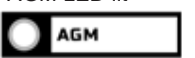
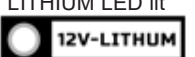

5.2. TEST-DISPLAY BUTTON

TEST-DISPLAY BUTTON		
Digital display	Indicator LED	Description
BAT.V	Voltage LED lit 	When the charger is NOT working in ENGINE START, the display will show the battery VOLTAGE.
BATT.%	Battery % LED lit 	When the charger is NOT working in ENGINE START, the digital display shows percentage of the battery connected to the charger's battery clamps.
ALTERNATOR	Alternator % LED lit 	The digital display shows an estimated output percentage of the vehicle's charging system connected to the charger's battery clamps, compared to a properly functioning system. The alternator percent range is from 0% to 100%. Readings below 0% (13.4 volts/26.8 volts) will read LO and readings above 100% (14.4 volts/28.8 volts) will read HI. If you get a HI or LO reading, have the electrical system checked by a qualified technician.





5.3. Battery type button

BAT. TYPE		
Digital display	LED indicator	Description
	NORMAL LED lit 	STANDARD)-Charged Voltage is 7.2V/14.4V/28.8V. When charging, pressing this button does NOT work.
	GEL LED lit 	(GEL)-Charged Voltage is 7.5V/14.5V/29V. When charging, pressing this button does NOT work
	AGM LED lit 	(AGM)-Charged Voltage is 7.8V/14.8V/29.6V. When charging, pressing this button does NOT work.
	LITHIUM LED lit 	Charging 12V lithium-ion batteries only, including (4-cell LiFePO4).



5.4. FUNCTION SELECTION BUTTON

FUNCTION	
Mode	Explanation
CHARGE 	The operating mode of the charger is charging mode.
SUPPLY 	Provide a stable output to help the equipment work normally and check and repair..
REPAIR 	Provide a positive pulse voltage to charge the battery that has been idle for a long time or the dead battery.



5.5. CURRENT SELECTION BUTTON

BAT.CURRENT	
Charging rate	Explanation
Slow 	Low current charging current gear.
Middle 	Average charging current gear
Fast 	Fast charging current gear

BATTERY VOLTAGE SELECTION BUTTON

BAT.CURRENT	
Charging rate	Explanation
6V 	6V battery type.
12V 	12V battery type.
24V 	24V battery type.

5.6. ENGINE START BUTTON

START ENGINE	
Engine starter time selection	Explanation
TIMER+ 	The time can be increased from 5 seconds to 15 seconds
TIMER- 	The time can be reduced from 15 seconds to 5seconds.







ENGINE START (press ENGINE START BUTTON to enter) – Provides additional amps for cranking an engine with a weak or run-down battery.

- WARNING:** Always use in combination with a battery. Must NOT touch or disconnect clamps when ENGINE START mode works, otherwise there may be serious injuries to people or property.

5.7. CONNECTING TO THE BATTERY



- 5.7.1. Identify polarity of battery posts. The positive battery terminal is typically marked by these letters or symbol (POS, P, +). The negative battery terminal is typically marked by these letters or symbol (NEG, N, -).
 - * **DO NOT** make any connections to the carburetor, fuel lines, or thin metal parts.
- 5.7.2. Identify if you have a negative or positive grounded vehicle. This can be done by identifying which battery post (NEG or POS) is connected to the chassis.
- 5.7.3. For a negative grounded vehicle (most common): connect the RED POSITIVE clamp first to the positive battery terminal, then connect the BLACK NEGATIVE clamp to the negative battery terminal or vehicle chassis.
- 5.7.4. For a positive grounded vehicle (very uncommon): connect the BLACK NEGATIVE clamp first to the negative battery terminal, then connect the RED POSITIVE clamp to the positive battery terminal or vehicle chassis.
- 5.7.5. When disconnecting, disconnect in the reverse sequence, removing the negative first (or positive first for positive ground systems).
- 5.7.6. A marine (boat) battery must be removed and charged on shore. To charge it on board requires equipment specially designed for marine use.

5.8. OPERATING STEPS

STEP NO	CONNECTION	STEP SELECT KEY
Step 1	Ensure battery connection.	Connect 6V/12V battery to the 6V/12V terminal, and 24V battery to the 24V terminal. Digital display: Connected battery voltage.
Step 2	Start machine.	
Step 3	Check battery voltage type.	
Step 4	Check charge current.	
Step 5	Check battery type.	
Step 6	Check function mode.	
Step 7	Stop or start operation.	

5.9. ENGINE START FUNCTION

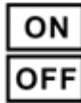
5.9.1. Your battery charger can be used to jump start your car if the battery is low. Follow all safety instructions and precautions for charging your battery. Wear complete eye protection and protective clothing. The procedures are as follows.

PROCEDURE	CONNECTION	SELECTION KEY
Step 1	Ensure battery connection.	Digital display: Connected battery voltage
Step 2	Start machine.	
Step 3	Select the engine start button and set the start time.	
Step 4	Stop or start the operation.	

- **Warning:** Using the ENGINE START feature WITHOUT a battery installed in the vehicle will damage the vehicle's electrical system.
- 5.9.2.1. With the charger unplugged from the AC outlet, connect the charger to the battery following the instructions given in the connecting to the battery 5.7section.
- 5.9.3.2. Plug the charger AC power cord into the AC outlet. With the charger plugged in and connected to the battery and chassis, press the ENGINE START button until the ENGINE START LED is lit.
NOTE: During extremely cold weather, or if the battery is under 2 volts, charge the battery for 5 minutes before cranking the engine.
- 5.9.4. Crank the engine until it starts or 3 seconds pass. If the engine does not start, wait 3 minutes before cranking again. This allows the charger and battery to cool down.
- 5.9.5. If the engine fails to start, use the BOOST rate to charge for 5 minutes before attempting to crank the engine again.
- 5.9.6. After the engine starts, unplug the AC power cord before disconnecting the battery clamps from the vehicle.
NOTE: If the engine does turn over but never starts, there is not a problem with the starting system; there is a problem somewhere else with the vehicle. STOP cranking the engine until the other problem has been diagnosed and corrected. During the starting sequence listed above, the charger is set to one of three states:
- 5.9.7. Wait for cranking – While waiting for cranking, the digital display shows START-READY. The charger waits until the engine is actually being cranked before delivering the amps for engine start. Press the remote button before cranking the engine immediately. If the remote is not used, the charger will automatically detect whether engine is trying to crank.
- 5.9.8. Cranking – When cranking is detected, the charger will automatically deliver up to its maximum output as required by the starting system for up to 5 times (15)seconds.
- 5.9.9. Cool Down – After cranking, the charger enters a mandatory 240 seconds cool down state. The remote or any button does NOT work. The digital display indicates the remaining cool down time in seconds. It starts at 240 and counts down to 0. After 4 minutes, the digital display will change from displaying the countdown to displaying START-READY. If using the engine starter again, please continue to press the remote button.

5.10. VOLTAGE TESTER AND CHARGER

When first turned on, the unit operates only as a tester, not as a charger.

If the "TEST" function is used, stop the "FUNCTION" and the corresponding working mode is turned off. Then select the "TEST" button to detect and view the connected battery voltage and Charge level.

NOTE: The battery tester is only designed to test batteries. Testing a device with a rapidly changing voltage could yield unexpected or inaccurate results.

5.11. ALTERNATOR CHECK

5.11.1. With the charger unplugged from the AC outlet, connect the charger to the battery, following the instructions given in previous sections.

5.11.2. Plug the charger AC power cord into the AC outlet.

5.11.3. Start the vehicle and turn on the vehicle's headlights. Read the state on the digital display. If you get a reading "0-100%", the alternator is working properly. If the reading is "LO" or "HI" , have the charging system checked by a qualified technician.

NOTE: When first turned on, the unit operates only as a tester, not as a charger. The charger must stop charging.

5.12. CHARGING STEPS

NO.	PROCEDURE	DIGITAL DISPLAY	LED INDICATOR	CHARGING STATE
1	ANALYSING 1	ANALYSING-1 BATT-6/12/24.	CHARGING LED lit.	Checks if battery has connected with the charger.
2	DESULPHATION	CHARGING BATT- 6/12/24.	CHARGING LED lit	Pulsing charging to remove sulphate
3	DESULPHATION	CHARGING BATT- 6/12/24.	CHARGING LED lit	Charges with gradually increasing charging current.
4	CONTROLLED CURRENT CHARGE	CHARGING BATT- 6/12/24	CHARGING LED lit	Adjusts the charging current intelligently.
5	ANALYSING 2	ANALYSING-2 BATT-6/12/24	CHARGING LED lit	Tests if the battery can absorb charge.
6	CONSTANT OUTPUT CHARGE	CHARGING BATT- 6/12/24	CHARGING LED lit	Charges with constant voltage and compensates fake full charge caused by high current charging
7	RECOVERY CYCLE CHARGE	CHARGING BATT- 6/12/24	CHARGING LED lit	Absorbs more charge and compensates side effect of reduced charging current.
8	ABSORPTION	CHARGING BATT- 6/12/24	CHARGING LED lit	Charges with constant trickle current for maximum battery voltage.
9	ANALYSING 3	ANALYSING-2 BATT-6/12/24	CHARGING LED lit	Tests if the battery can hold charge.
10	MAINTENANCE	MAINTAINING BATT-6/12/24	CHARGING LED lit	Continuously monitors the battery, and charges with trickle current once the voltage is lower than threshold

6. TROUBLESHOOTING

DIGITAL DISPLAY	WARNING LED INDICATOR	MEANING	SOLUTION
E01	WARNING LED lit.	The connections are reversed.	Change red and black clamps or ring terminals to the correct battery posts.
E02	WARNING LED lit.	Output current reduces to 0 when temperature in charger is too high.	DO NOT remove the AC plug immediately. After cooling down, the battery charger will work again.
E03	WARNING LED lit.	Charging in 12V Mode for 24V battery or charging in 6V Mode for 12V/24V battery.	Replace the battery or connect the positive output line to the correct connector.
E04	WARNING LED lit.	The battery cannot store electric charge (dead battery) Or battery cannot be Recovered through Recover Process.	Try the REPAIR MODE or Replace the battery with a new one.
E05	WARNING LED lit.	Overload in SUPPLY Mode (will automatically Shut down for 30 seconds as protection).	Disconnect the external device.
0.0V	WARNING LED lit.	No battery connected / battery voltage is lower than 1 volt (dead battery) / red and black clamps are connected together.	1) Connect the red and black clamps or ring terminals to battery posts. 2) Clean the battery posts. 3) Replace the battery with a new one immediately 4) Disconnect red and black output terminals.

7. MAINTENANCE

7.1. To reduce risk of electric shock, unplug charger from outlet before attempting any maintenance or cleaning.

7.2. HANDLING

For transport make sure to only move it with the handle provided and that there are no obstacles that could cause it to stop and topple suddenly when being pushed/pulled. If it needs to go in a vehicle to be transported to make sure it is securely fastened.



ENVIRONMENT PROTECTION

Recycle unwanted materials instead of disposing of them as waste. All tools, accessories and packaging should be sorted, taken to a recycling centre and disposed of in a manner which is compatible with the environment. When the product becomes completely unserviceable and requires disposal, drain any fluids (if applicable) into approved containers and dispose of the product and fluids according to local regulations.



REGISTER YOUR PURCHASE HERE



WEEE REGULATIONS

Dispose of this product at the end of its working life in compliance with the EU Directive on Waste Electrical and Electronic Equipment (WEEE). When the product is no longer required, it must be disposed of in an environmentally protective way. Contact your local solid waste authority for recycling information.

Note: It is our policy to continually improve products and as such we reserve the right to alter data, specifications and component parts without prior notice.

Important: No Liability is accepted for incorrect use of this product.

Warranty: Guarantee is 12 months from purchase date, proof of which is required for any claim.

Sealey Group, Kempson Way, Suffolk Business Park, Bury St Edmunds, Suffolk. IP32 7AR

01284 757500

sales@sealey.co.uk

www.sealey.co.uk