

Thank you for purchasing a Sealey product. Manufactured to a high standard this product will, if used according to these instructions and properly maintained, give you years of trouble free performance.

IMPORTANT: PLEASE READ THESE INSTRUCTIONS CAREFULLY. NOTE THE SAFE OPERATIONAL REQUIREMENTS, WARNINGS & CAUTIONS. USE THE PRODUCT CORRECTLY AND WITH CARE FOR THE PURPOSE FOR WHICH IT IS INTENDED. FAILURE TO DO SO MAY CAUSE DAMAGE AND/OR PERSONAL INJURY AND WILL INVALIDATE THE WARRANTY. PLEASE KEEP INSTRUCTIONS SAFE FOR FUTURE USE.

1. SAFETY INSTRUCTIONS

1.1. ELECTRICAL SAFETY

WARNING! It is the responsibility of the owner and the operator to read, understand and comply with the following: You must check all electrical products, before use, to ensure that they are safe. You must inspect power cables, plugs, sockets and any other connectors for wear or damage. You must ensure that the risk of electric shock is minimised by the installation of appropriate safety devices. A Residual Current Circuit Breaker (RCCB) should be incorporated in the main distribution board. We also recommend that a Residual Current Device (RCD) is used. It is particularly important to use an RCD with portable products that are plugged into a supply which is not protected by an RCCB. If in any doubt consult a qualified electrician. You may obtain a Residual Current Device by contacting your Sealey dealer. **You must** also read and understand the following instructions concerning electrical safety.

- 1.1.1. The **Electricity at Work Act 1989** requires all portable electrical appliances, if used on business premises, to be tested by a qualified electrician, using a Portable Appliance Tester (PAT), at least once a year.
- 1.1.2. The **Health & Safety at Work Act 1974** makes owners of electrical appliances responsible for the safe condition of those appliances and the safety of the appliance operators. **If in any doubt about electrical safety, contact a qualified electrician.**
- 1.1.3. Ensure that the insulation on all cables and on the appliance is safe before connecting it to the power supply. See 1.1.1. and 1.1.2. and use a Portable Appliance Tester.
- 1.1.4. Ensure that cables are always protected against short circuit and overload.
- 1.1.5. Regularly inspect power supply cables and plugs for wear or damage and check all connections to ensure that none is loose.
- 1.1.6. **Important:** Ensure that the voltage marked on the appliance matches the power supply to be used and that the plug is fitted with the correct fuse - see fuse rating at right.
- 1.1.7. **DO NOT** pull or carry the appliance by the power cable.
- 1.1.8. **DO NOT** pull the plug from the socket by the cable.
- 1.1.9. **DO NOT** use worn or damaged cables, plugs or connectors. Immediately have any faulty item repaired or replaced by a qualified electrician. When an ASTA/BS approved UK 3 pin plug is damaged, cut the cable just above the plug and **dispose of the plug safely.** Fit a new plug according to the following instructions (UK only).
 - a) **Connect the GREEN/YELLOW earth wire to the earth terminal 'E'.**
 - b) **Connect the BROWN live wire to the live terminal 'L'.**
 - c) **Connect the BLUE neutral wire to the neutral terminal 'N'.**
 - d) **After wiring, check that there are no bare wires, that all wires have been correctly connected, that the cable outer insulation extends beyond the cable restraint and that the restraint is tight.**

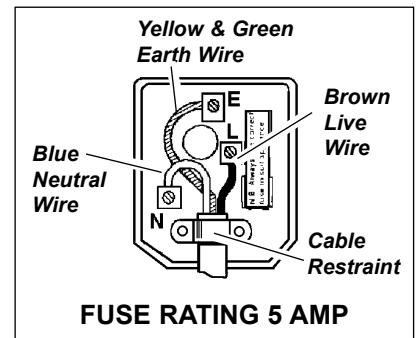

Double insulated products, which are always marked with this symbol , are fitted with live (brown) and neutral (blue) wires only. To rewire, connect the wires as indicated above - **DO NOT** connect either wire to the earth terminal.

- 1.1.10. Products which require more than 13 amps are supplied without a plug. In this case you must contact a qualified electrician to ensure that a suitably rated supply is available. We recommend that you discuss the installation of an industrial round pin plug and socket with your electrician.
- 1.1.11. If an extension reel is used it should be fully unwound before connection. A reel with an RCD fitted is preferred since any appliance plugged into it will be protected. The cable core section is important and should be at least 1.5mm², but to be absolutely sure that the capacity of the reel is suitable for this product and for others which may be used in the other output sockets, we recommend the use of 2.5mm² section cable.

1.2. GENERAL SAFETY

- ✓ Familiarise yourself with the applications, limitations and potential hazards of the sander.
- ☐ **WARNING!** Ensure all Health and Safety, local authority, and general workshop practice regulations are strictly adhered to.
- ☐ **WARNING!** Disconnect from the mains power supply before changing accessories, servicing or performing any maintenance.
- ☐ **WARNING! DO NOT** sand any materials containing asbestos.
- ✓ Maintain and keep the sander in good condition (use an authorised service agent).
- ✓ Check the alignment of moving parts regularly. For safest performance keep the sander clean at all times.
- ✓ Before each use check all abrasive attachments for condition. If worn or damaged replace immediately.
- ✓ Replace or repair damaged parts. Use recommended parts only. Unauthorised parts are dangerous and will invalidate the warranty.
- ✓ Locate the sander in a suitable work area. Keep the area clean, uncluttered and ensure that there is adequate lighting.
- ✓ Ensure that the sander is situated on a solid work surface, adequate for supporting the weight of the sander and the workpiece.
- ✓ Ensure that there are no flammable or combustible materials near the work area.
- ✓ Remove ill fitting clothing, ties and loose jewellery and tie back long hair. Keep hands and body clear of the worktable when operating the sander.
- ✓ Maintain correct balance and footing, ensure that the floor is not slippery and wear non-slip rubber soled footwear.
- ✓ Wear approved safety eye or face protection, gloves, ear defenders and respiratory protection when operating the sander.
- X **DO NOT** use the sander for any purpose other than that for which it is designed.
- X **DO NOT** get the sander wet or use in damp or wet locations or areas where there is condensation.
- X **DO NOT** operate the sander when you are tired, under the influence of alcohol, drugs or intoxicating medication.
- X **DO NOT** touch the abrasive whilst operating, or whilst sander is plugged into the mains power and avoid unintentional starting.
- X **DO NOT** switch the sander on while the workpiece is in contact with the abrasive and **DO NOT** leave the sander running unattended.
- X **DO NOT** operate the sander if any parts are damaged or missing as this may cause failure and/or possible personal injury.
- X **DO NOT** allow children or untrained persons to operate the sander. Keep them away from the work area.
- X **DO NOT** remove the safety guard whilst sander is in use.
- ✓ When not in use unplug from the mains power supply and make every effort to ensure the sander is childproof.

2. TECHNICAL SPECIFICATION

Belt915 x 100mm
 Belt Speed460mtr/min
 Disc Diameter150mm

Disc Speed2950rpm
 Table225 x 160mm
 Table Tilt45°

Dust Extraction Port35mm
 Motor500W 230V
 Weight22kg

3. ASSEMBLY & ADJUSTMENT

- 3.1. Unpack the sander and check contents. Should there be any damaged or missing parts contact your supplier immediately.
- 3.2. Attach a sanding disc (fig 2.1) to the back plate by removing the self adhesive backing and carefully applying the disc to the plate.
 Note: Your model may arrive with a disc already applied.
- 3.3. Insert table support rod (fig 1.1) into boss below and to left of disc (fig 2.2) and lock in place with bolt.
- 3.4. The angle of the table may be adjusted by loosening locking nut (fig 1.4) and positioning the angle gauge (3) accordingly.
- 3.5. The mitre gauge (fig 2.3) base bar locates in the groove in the table top (fig 1.2).
- 3.6. Bolt sander to a stable, fireproof bench or table which is strong enough to take the weight of the sander and the workpiece.

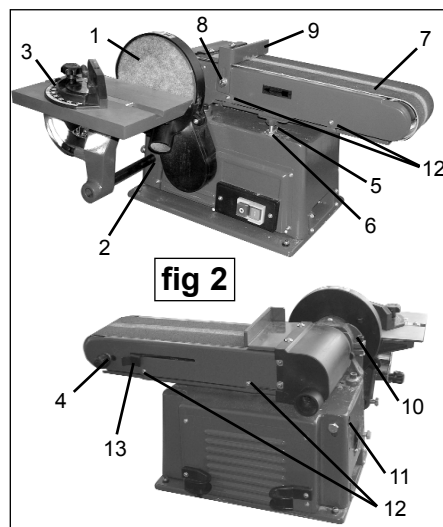
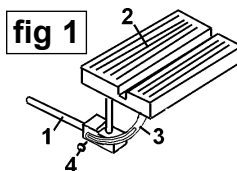

4. OPERATING INSTRUCTIONS

- ❑ **WARNING! Before each use** rotate the sanding disc by hand to check it is undamaged and secure. Remove adjusting keys and wrenches before turning the sander on. *Ensure you wear approved safety goggles, gloves, ear defenders and respiratory protection.*
- ❑ **WARNING! DO NOT** switch the sander on whilst the workpiece is in contact with the disc or belt. Keep all guards and holding screws in place, tight and in good working order. A guard or other part that is damaged must be repaired or replaced **before** the sander is next used, if damaged replace parts. The safety guards are mandatory when the sander is used in premises covered by the Health & Safety at Work Act.

4.1. SANDING BELT (fig 2.G).

- 4.1.1. If the belt does not run centrally on the drums the tracking should be adjusted by turning knob (fig 2.4).
- 4.1.2. To stabilise the sanding bed, unscrew support bolt (fig 2.5) until it 'butts' up to the underside of the sanding belt bed and lock with nut.
- 4.1.3. The sanding belt bed (fig 2.7) may be rotated through 90° from the horizontal and locked for operating in a vertical position (fig 3).
- 4.1.4. To alter the bed angle, remove the end guard by removing bolt (fig 2.8) and two screws on topside of guard, withdraw guard (fig 2.9).
- 4.1.5. Loosen the clamp nut (fig 2.10) located adjacent to upper pulley (behind sanding disc at rear). Pull the sanding belt upright and tighten the lock nut. Fit the sanding table to mount (fig 2.11) and adjust to the desired angle. When returning to horizontal position ensure you replace the guard.

4.2. SANDING TABLE.

- 4.2.1. The table may be tilted through 45° by loosening thumb screw (fig 1.4).
- 4.2.2. When operating sanding bed in the vertical position (fig 3), mount sanding table at the foot of the belt by:
 - a. Remove table assembly and support rod (fig 1.1) from the sanding disc position.
 - b. Insert table support rod (fig 1.1) into rear mounting boss (fig 2.11) and fix with locking bolt.
 - c. Align table as required and tighten all bolts.

5. MAINTENANCE

- ❑ **WARNING! Disconnect sander from the electrical supply before performing any service or maintenance.**
- 5.1. Keep the sander clean and replace a worn or damaged sanding belt or disc.
- 5.2. To change sanding belt remove the guard (fig 2.9), remove bottom tray by removing four screws (fig 2.12).
- 5.3. Push belt tension lever (fig 2.13) fully to the right. Remove old belt. Place new belt over the two drums (note direction arrows on the inside of the belt). Move the tension lever back to the left. Replace guard and bottom tray and then adjust belt tracking if necessary.
- 5.4. Replace sanding disc pad. Remove table and disc guard. Peel off of pad, and stick new pad in place.
- 5.5. Periodically lubricate the drive bearings. DO NOT lubricate motor bearing. The motor is a sealed unit.

Replacement Sanding Belts:
 SM14/B060G 60Grit
 SM14/B100G 100Grit

Replacement Sanding Disc:
 SM14/D080G 80Grit

fig 3

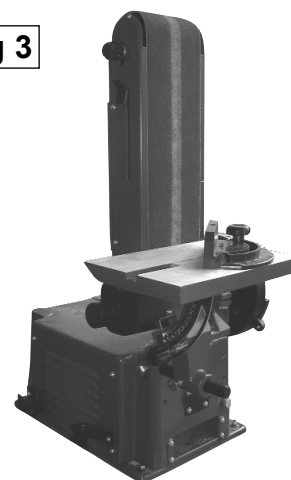

5.6 CHANGING DRIVE BELT

- 5.6.1 Remove the circular sanding disc to gain access to the allen bolt that secures the aluminium sanding plate.
 5.6.2 Remove the allen bolt and washer (fig 4), followed by the bolt cup (fig 5), you can then see the Woodruff Key (fig 6). When refitting the disc plate you must align the groove in the disc with the Woodruff Key.

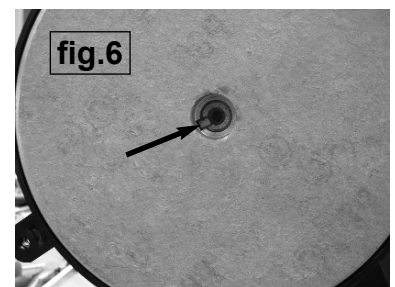
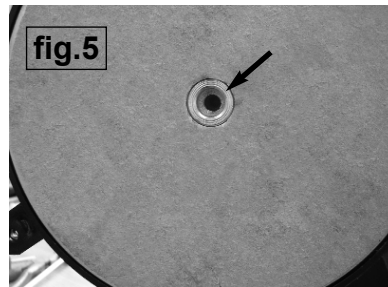
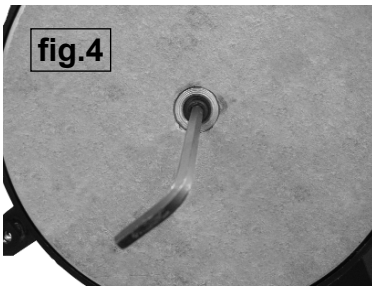

- 5.6.3 When the disc has been removed, undo the lower cover screw (fig 7) and the upper cover screw (fig 8), remove the disc belt cover.
 5.6.4 Remove the old belt.
 5.6.5 Fit the new belt over the lower motor spindle pulley and over the top pulley as in fig 9. To help engage the belt pulley with the top pulley teeth, rotate the motor spindle anti-clockwise while applying horizontal pressure to the belt at the top pulley (fig 9). Ensure the belt is correctly located on both pulleys. Fig 10 shows the belt in the correct location on the upper pulley.

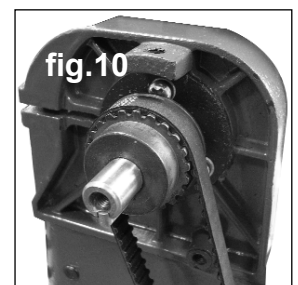
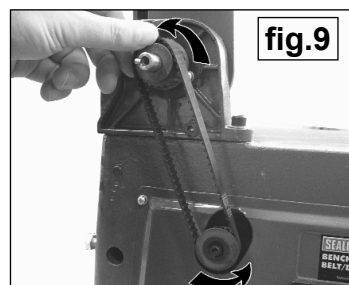
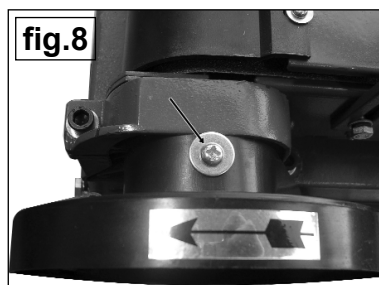
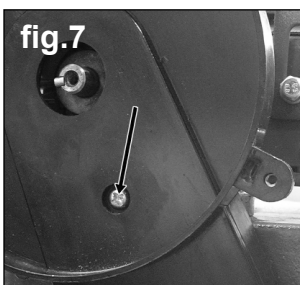

- 5.6.6 The correct belt tension is shown in fig 11, with a firm pressure you should be able to squeeze the belt 5mm on each side. **Do not** over tighten as this will damage the motor bearings and belt. The belt should not be slack as it may run off the pulleys during use.
 5.6.7 The belt tensioners are shown in (fig 12 "horizontal adjusters" & 13 "vertical adjuster").
 5.6.8 When squeezing the belt; if the motor pulley rises, adjust the vertical adjuster (fig 13) until there is no more vertical play in the motor.
Note: When you are satisfied the belt tension is correct, turn the belt through a couple of revolutions to ensure belt, pulleys etc. all turn freely.
 5.6.9 Re-assembly is a reversal of procedures 5.6.1 to 5.6.3.

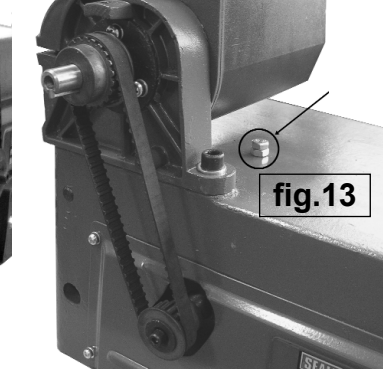
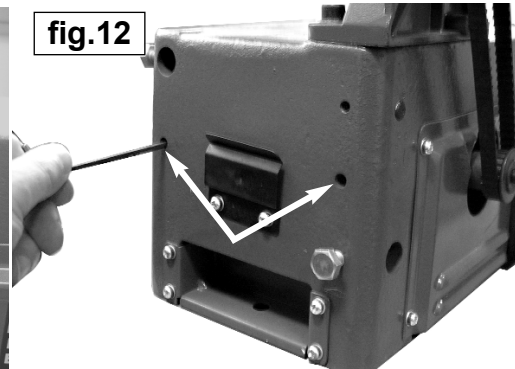
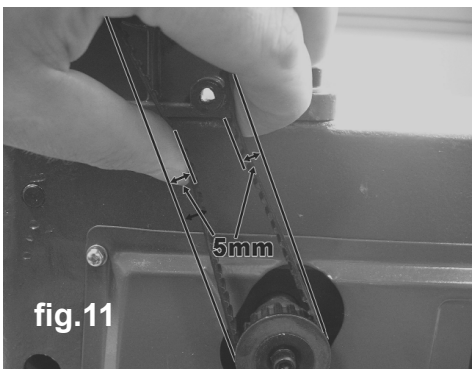

WARNING: The warnings, cautions and instructions discussed in this manual cannot cover all possible conditions and situations that may occur. It must be understood that common sense and caution are factors which cannot be built into this product, but must be applied by the operator.

6. DECLARATION OF CONFORMITY

BENCH TOP BELT/DISC SANDER
Model SM14.V5
 2006/95/EC Low Voltage Directive
 2004/108/EC EMC Directive
 2006/42/EC Machinery Directive
 93/68/EEC CE Marking Directive
 2002/95/EC RoHS Directive
 2002/96/EC WEEE Directive

Declaration of Conformity We, the sole importer into the UK, declare that the product listed here is in conformity with the following standards and directives.

CE Signed by Steve Buckle *Steve Buckle*

18th September 2007

The construction file for this product is held by the Manufacturer and may be inspected, by a national authority, upon request to Jack Sealey Ltd. For Jack Sealey Ltd. Sole importer into the UK of Sealey Quality Machinery.

NOTE: It is our policy to continually improve products and as such we reserve the right to alter data, specifications and component parts without prior notice.

IMPORTANT: No liability is accepted for incorrect use of this product.

WARRANTY: Guarantee is 12 months from purchase date, proof of which will be required for any claim.

INFORMATION: For a copy of our catalogue and latest promotions call us on 01284 757525 and leave your full name, address and postcode.

	Sole UK Distributor Sealey Group, Bury St. Edmunds, Suffolk.	01284 757500	www.sealey.co.uk sales@sealey.co.uk
		01284 703534	