

INSTRUCTIONS FOR METAL WORKING LATHE

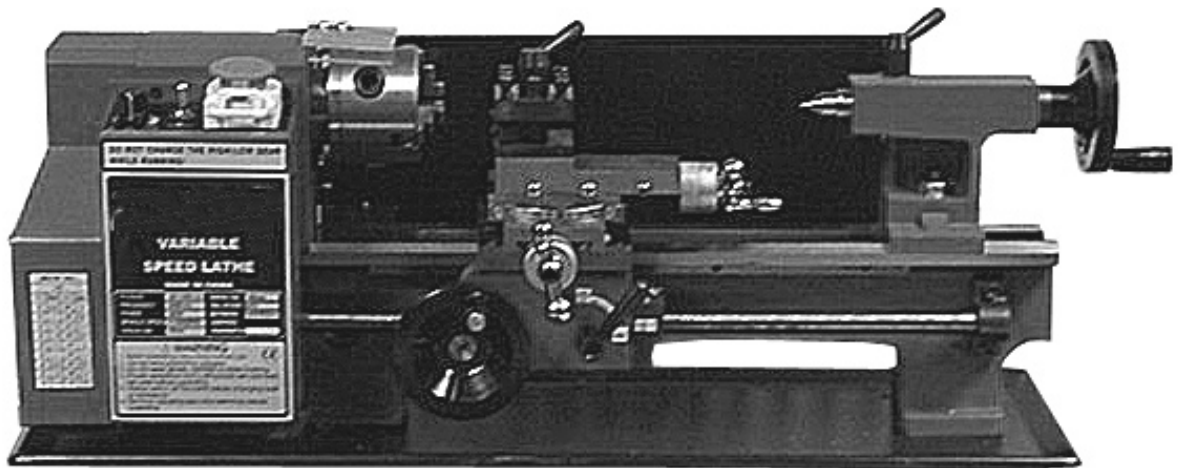

MODEL NO: **SM3002.V2**

Thank you for purchasing a Sealey product. Manufactured to a high standard this product will, if used according to these instructions and properly maintained, give you years of trouble free performance.



IMPORTANT: PLEASE READ THESE INSTRUCTIONS CAREFULLY. NOTE THE SAFE OPERATIONAL REQUIREMENTS, WARNINGS AND CAUTIONS. USE THIS PRODUCT CORRECTLY AND WITH CARE FOR THE PURPOSE FOR WHICH IT IS INTENDED. FAILURE TO DO SO MAY CAUSE DAMAGE AND/OR PERSONAL INJURY AND WILL INVALIDATE THE WARRANTY. PLEASE KEEP INSTRUCTIONS SAFE FOR FUTURE USE.

1. SAFETY INSTRUCTIONS

1.1. ELECTRICAL SAFETY

WARNING! It is the responsibility of the owner and the operator to read, understand and comply with the following:

You must check all electrical products, before use, to ensure that they are safe. You must inspect power cables, plugs, sockets and any other connectors for wear or damage. You must ensure that the risk of electric shock is minimised by the installation of appropriate safety devices. A Residual Current Circuit Breaker (RCCB) should be incorporated in the main distribution board. We also recommend that a Residual Current Device (RCD) is used. It is particularly important to use an RCD with portable products that are plugged into a supply which is not protected by an RCCB. If in any doubt consult a qualified electrician. You may obtain a Residual Current Device by contacting your Sealey dealer.

You must also read and understand the following instructions concerning electrical safety.

1.1.1. The **Electricity at Work Act 1989** requires all portable electrical appliances, if used on business premises, to be tested by a qualified electrician, using a Portable Appliance Tester (PAT), at least once a year.

1.1.2. The **Health & Safety at Work Act 1974** makes owners of electrical appliances responsible for the safe condition of those appliances and the safety of the appliance operators. **If in any doubt about electrical safety, contact a qualified electrician.**

1.1.3. Ensure that the insulation on all cables and on the appliance is safe before connecting it to the power supply. See 1.1.1. and 1.1.2. and use a Portable Appliance Tester.

1.1.4. Ensure that cables are always protected against short circuit and overload.

1.1.5. Regularly inspect power supply cables and plugs for wear or damage and check all connections to ensure that none is loose.

1.1.6. **Important:** Ensure that the voltage marked on the appliance matches the power supply to be used and that the plug is fitted with the correct fuse - see fuse rating at right.

1.1.7. **DO NOT** pull or carry the appliance by the power cable.

1.1.8. **DO NOT** pull the plug from the socket by the cable.

1.1.9. **DO NOT** use worn or damaged cables, plugs or connectors. Immediately have any faulty item repaired or replaced by a qualified electrician. When a BS 1363/A UK 3 pin plug is damaged, cut the cable just above the plug and **dispose of the plug safely.**

Fit a new plug according to the following instructions (UK only).

a) **Connect the GREEN/YELLOW earth wire to the earth terminal 'E'.**

b) **Connect the BROWN live wire to the live terminal 'L'.**

c) **Connect the BLUE neutral wire to the neutral terminal 'N'.**

d) **After wiring, check that there are no bare wires, that all wires have been correctly connected, that the cable outer insulation extends beyond the cable restraint and that the restraint is tight.**

Double insulated products, which are always marked with this symbol , are fitted with live (brown) and neutral (blue) wires only. To rewire, connect the wires as indicated above - **DO NOT** connect either wire to the earth terminal.

1.1.10. Products which require more than 13 amps are supplied without a plug. In this case you must contact a qualified electrician to ensure that a suitably rated supply is available. We recommend that you discuss the installation of an industrial round pin plug and socket with your electrician.

1.1.11. If an extension reel is used it should be fully unwound before connection. A reel with an RCD fitted is preferred since any appliance plugged into it will be protected. The cable core section is important and should be at least 1.5mm², but to be absolutely sure that the capacity of the reel is suitable for this product and for others which may be used in the other output sockets, we recommend the use of 2.5mm² section cable.

1.2. GENERAL SAFETY

WARNING! Disconnect the lathe from the mains power and ensure that the chuck is at a complete standstill before attempting to change accessories, service or perform any maintenance.

✓ Maintain the lathe in good condition (use an authorised service agent).

✓ Replace or repair damaged parts. *Use recommended parts only. Unauthorised parts may be dangerous and will invalidate the warranty.*

✓ Locate the lathe in a suitable area. Ensure that the mounting surface is flat and firm. Keep the area clean and tidy and free from unrelated materials, and ensure that there is adequate lighting.

✓ Keep the lathe clean for best and safest performance.

WARNING! Before each use check that chuck, cutting tool and tailstock are secure and not worn or damaged. If any part of the lathe is worn or damaged replace immediately.

WARNING! Keep guard and holding fixings in place, tight and in good working order. Check regularly for damaged parts.

A guard that is damaged or missing must be repaired or replaced before the tool is next used. The safety guard is a mandatory fitting when the lathe is used in premises covered by the Health & Safety at Work Act.

✓ Remove adjusting keys and wrenches from the lathe and its vicinity before turning it on.

WARNING! Wear approved safety eye protection and, if oil mist is generated, respiratory protection.

✓ Remove ill fitting clothing. Remove ties, watches, rings and other loose jewellery and contain long hair.

✓ Keep hands and body clear of the workpiece when operating the lathe.

✓ Maintain correct balance and footing. Ensure that the floor is not slippery and wear non-slip shoes.

✓ Keep children and unauthorised persons away from the work area.

WARNING! DO NOT switch on the lathe whilst the cutting tool is in contact with the workpiece. Bring the cutting tool gradually to the workpiece.

✓ Avoid un-intentional starting of the lathe.

x DO NOT use the lathe for a task it is not designed to perform.

x DO NOT allow untrained persons to operate the lathe.

x DO NOT get the lathe wet or use in damp or wet locations or areas where there is condensation.

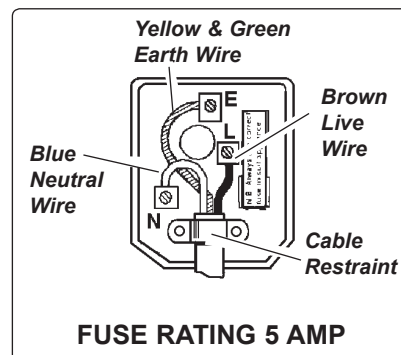

- ❑ **WARNING!** DO NOT use the lathe where there are flammable liquids, solids or gases such as petrol, paint solvents, waste wiping rags etc.
- x DO NOT operate the lathe if any parts are missing or damaged as this may cause failure and/or personal injury.
- x DO NOT lift or remove the chuck guard whilst the lathe is in use.
- x DO NOT touch the workpiece close to the cut as it will be very hot. Allow to cool.
- x DO NOT leave the lathe running unattended.
- x DO NOT operate the lathe when you are tired or under the influence of alcohol, drugs or intoxicating medication.
- ✓ When not in use switch off the lathe and isolate from the power supply.

2. INTRODUCTION & SPECIFICATION

Precision built metal working lathe, ideal for the small workshop, professional or home engineer and model maker. Powered by a 300Watt motor this compact unit features variable speed reversible drive and powered cutting facility for right and left hand threads. Supplied with self centring three jaw chuck, four-way tool post, swarf tray and rear splash guard. Complies with Safety of Machinery (Safety) Regulations 1992 (and amendments), is fully CE approved and supplied with emergency stop button and chuck guard. An optional stand is available, order Model No. SM3002ST.

Specification:

Motor 300W - 230V 50Hz
 Spindle Speed Range 100-2500rpm
 Distance Between Centres..... 300mm
 Centre Height 90mm
 Max. Workpiece Diameter 180mm
 Spindle Bore..... 20mm

Spindle Taper MT3
 Tailstock Taper MT2
 Cross Slide Travel 65mm
 Leadscrew Metric
 Dimensions..... 300x300x830mm
 Weight 40kg

3. CONTENTS & ASSEMBLY

Contents description:

- Lathe
- 2 Handwheel Handles (with bolts and nuts)
- Tailstock Centre
- 3 External Chuck Jaws
- 6 Gears (30, 35, 2 x 40, 50 & 60 Teeth)
- 4 Rubber Feet
- 4 Screws
- Swarf Tray
- 1 Chuck Key
- 4 Hex Keys
- 2 Spanners
- 2A Fuse
- Machine Oil

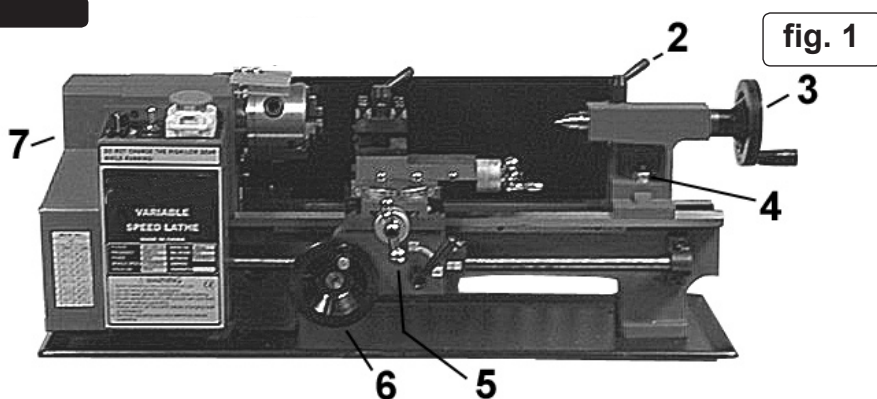

❑ **WARNING! Safe handling will require two people.**

- 3.1. Unpack the product and check that all components and tools are present and undamaged. If any problem is noted contact your supplier immediately.
- 3.2. The machine has been coated with grease to protect it in shipping. Remove the coating with commercial degreaser, kerosene or similar solvent before use. After degreasing coat the machined surfaces with machine oil.
- 3.3. Position the lathe on a sturdy workbench or on the optional stand (SM3002/ST). The lathe may be mounted on the rubber feet provided or bolted directly to the workbench through M6 clearance holes dimensioned as in fig. 2.
- 3.4. Take the the two handles and drop a bolt through each one. Screw a nut to the bolt until it touches the handle, then back it off approximately half a turn so that the handle rotates freely on the bolt.
- 3.5. Screw the bolt of one handle into the saddle feed handwheel (fig. 1.6) and the other into the tailstock feed handwheel (fig. 1.3). in each case, lock the bolt in place with the nut, ensuring that the handle can still rotate freely on the bolt.
- 3.6. The cross-slide feed handle (fig. 1.5) is fitted reversed for transit. Remove the handle and refit the correct way round.

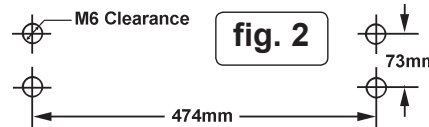

4. SET-UP AND OPERATION

It is assumed that the operator has experience of machining practice and these instructions are intended only to describe the features of the lathe. If you have no experience of machining it is recommended that you undertake training before using this machine.

❑ **WARNING! Before operating the lathe ensure that you are wearing approved safety goggles and gloves to protect you from swarf and metal particles. If using cutting oil or coolant a face mask may be necessary to avoid breathing any vapour generated. Ensure that all other safety instructions in Section 1 are followed carefully.**

4.1. Initial start-up

- 4.1.1. Check that the forward/reverse switch (fig. 3.B) is in the Off position and that the speed control (fig. 3.A) is on zero.
- 4.1.2. Set the high/low range lever (fig. 4.A) to Low and the automatic feed lever (fig. 5.A) to disengaged - turn anticlockwise.
- 4.1.3. Confirm that the cross-slide is well clear of the chuck and that all keys, spanners etc. are clear of the machine.

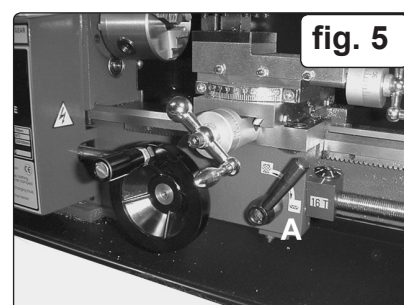
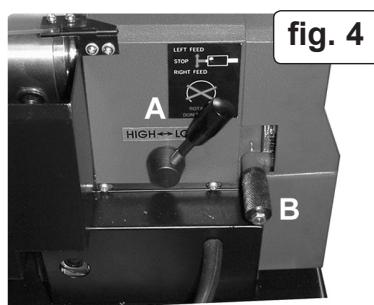
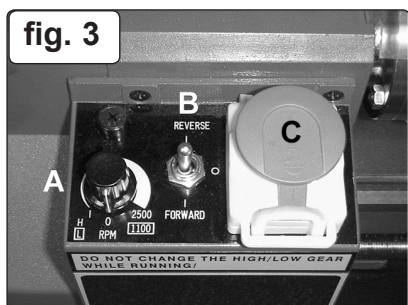

- 4.1.4. Connect the lathe to the mains supply.
- 4.1.5. Move the forward/reverse switch (fig. 3.B) to Forward and then release the emergency stop switch (fig. 3.C) by pushing the red cover up in the direction of the arrow.
- 4.1.6. Switch on the lathe by slowly turning the speed control (fig. 3.A) clockwise.
- 4.1.7. For this initial start-up run the lathe for about five minutes, gradually increasing the speed up to maximum. Run at maximum for a further two minutes.
- 4.1.8. Switch off the lathe by turning the speed control (fig. 3.A) anticlockwise to zero and then moving the forward/reverse switch (fig. 3.B) to Off. Disconnect from the mains supply.
- 4.1.9. Check that nothing on the lathe has worked loose and that the mounting bolts, if used, are secure.
- 4.1.10. Repeat the above running and checking but with the high/low range lever in the High position.

4.2. Headstock

The headstock spindle, which is belt driven, has a flange with mounting holes for chuck etc. and a number 3 Morse taper (internal) for a spindle centre (see Accessories Section) .

4.3. Tailstock

The tailstock spindle has a number 2 Morse taper (internal) for a centre or chuck. A plain centre is provided. See Accessories Section for the rolling centre and tailstock chuck. The spindle is positioned using the feed handle (fig.1.3) and then locked with the locking handle (fig. 1.2).

The tailstock base may be moved along the lathe bed as necessary and locked in position by the clamping nut (fig. 1.4).

4.4. Tool Rest

Up to four tools can be mounted on the tool rest. The rest can be rotated, in 90° steps, by slackening the locking handle (fig. 6.A), and slightly lifting the rest. **Always** ensure that the locking handle and tool clamp screws (fig. 6.B) are tight before starting to cut.

The tool rest is mounted on the compound slide, which in turn is mounted on the cross slide. The compound slide can be rotated ±45° on the cross slide to permit **bevel and taper cutting**. To rotate the compound slide, wind the tool rest fully to the right to reveal the two clamp screws (fig. 6.C). Loosen the clamp screws, rotate the slide to the required angle and then tighten the clamp screws.

4.5. Chuck

The chuck is supplied with internal jaws fitted and a set of external jaws. To remove and fit jaws proceed as follows:

Using the chuck key, fully wind out the fitted jaws, at which point they can be pulled from the chuck.

The thread segments on the jaws are staggered and therefore the jaws are numbered 1 to 3 and must be fitted in this sequence, in an anticlockwise direction (facing the chuck).

Turn the chuck key anticlockwise while watching the chuck thread in one of the jaw slots. When the end of the thread has just cleared the slot stop turning the key and insert jaw 1 into this slot. Insert the other two jaws in the other slots in sequence. Hold them under light pressure whilst turning the key clockwise until they are picked up by the thread and start to move inwards.

Check that the three jaws come together correctly at the centre of the chuck. If not, repeat the procedure.

❑ **WARNING! Before starting the lathe always confirm that nothing will contact the chuck by rotating the chuck by hand with the tool rest as far to the left as it will be during the turning operation. Make sure that the chuck guard is in place, as shown in fig. 1.1.**

4.6. Turning

4.6.1. Mount the cutting tool in the tool rest such that the tip of the tool is level with, or just below, the lathe centre line. Check this by aligning the tool tip with the point of the tailstock. **The tool tip must not be above the centre line.** The height of the tool tip may be adjusted by shimming or grinding the tool.

4.6.2. Mount the workpiece in the chuck and if necessary, support the other end with the tailstock. Steady and Follow Rests are also available, see Accessories Section.

4.6.3. Set the speed range, forward/reverse control and autofeed lever to suit the job.

4.6.4. Start the lathe by slowly turning the speed control clockwise until the required turning speed is reached.

4.7. Turning with auto feed

4.7.1. Proceed as in 4.6. but in 4.6.3. also set the lead screw lever (fig. 4.B) to Forward.

4.7.2. Position the tool just to the right of the end of the workpiece, start the lathe and adjust the speed control knob to achieve the desired turning speed.

4.7.3. Push down the auto feed lever (fig. 5.A) to engage the lead screw. The tool will now move to the left and begin cutting.

4.7.4. Be ready to disengage the leadscrew when the tool reaches the end of the cut. **DO NOT** allow the tool to over-travel and come into contact with the chuck. Always be prepared to hit the emergency stop button if the leadscrew cannot be disengaged.

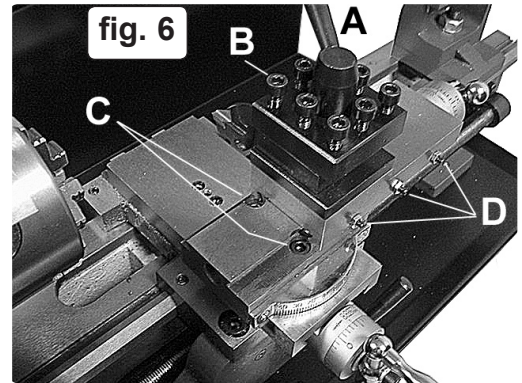
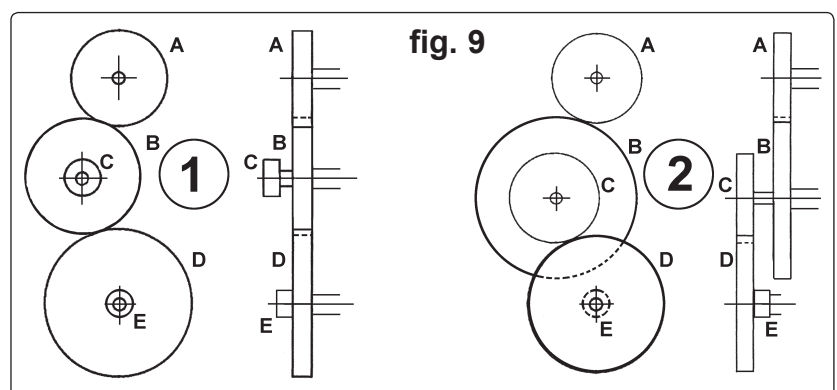
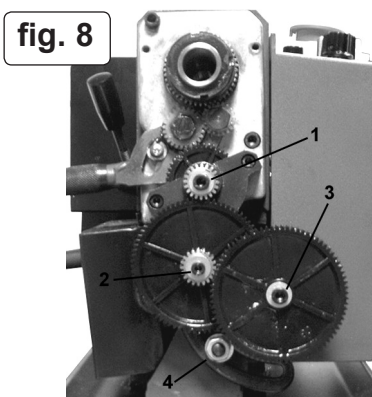

fig. 7

Thread Pitch	Gear Size (Teeth)				Dial
	A	B	C	D	
0.4	20	50	40	60	1, 3, 5 or 7
0.5	20	50	-	60	Any
0.6	40	50	30	60	Any
0.7	40	50	35	60	1, 4 or 5
0.8	40	50	40	60	1 or 5
1.0	20	60	-	30	Any
1.25	50	40	-	60	1, 3, or 5
1.5	40	60	-	40	Any
1.75	35	60	-	30	1, 4 or 5
2.0	40	60	-	30	Any
Turning	20	80	20	80	-



4.8. Screw cutting

Similar to turning with auto feed except that the feed rate is very much faster, demanding increased care from the operator.

- 4.8.1. Select the required leadscrew gear train from the chart (fig. 7).
 - 4.8.2. Undo the headstock end cover (fig. 1.7) retaining screws and remove the cover.
 - 4.8.3. Undo the three gear retaining screws (fig. 8. 1, 2 & 3), using the chuck key to hold the chuck (and therefore the gear train) if necessary. Slacken the adjuster nut (fig. 8.4).
 - 4.8.4. Replace the existing gears with those required, in the positions shown in fig. 9, taking care to retain the drive keys in each shaft. Note that where only gears A, B and D are specified, spacer E is fitted after gear D (fig. 9.1) - D then meshes with B. If a gear C is specified then note that the gear D shaft spacer E must go on the shaft before the gear, which will then mesh with gear C (fig. 9.2).
 - 4.8.5. Adjust gear B, or gears B and C, so that the train meshes with minimum backlash but without being tight.
 - 4.8.6. Tighten adjuster nut (fig. 7.4) and refit the end cover. **DO NOT operate the lathe without the end cover fitted.**
 - 4.8.7. Mount the workpiece in the lathe with the left hand end of the intended thread as far from the chuck as possible.
 - 4.8.8. Ensure that the automatic feed is disengaged (fig. 5.A) and that the leadscrew lever (fig. 4.B) is set to Forward.
 - 4.8.9. With the tool positioned for the first cut, switch on the lathe and set to the appropriate speed.
- Note: In order that the second and subsequent cuts start at the same place as the first cut it is vitally important that the indicator dial (fig. 10) is used, as follows, when starting each cut.
- 4.8.10. From the chart (fig. 7) read the dial number(s) relating to the thread to be cut. If there is a choice, select a specific number.
 - 4.8.11. Engage the automatic feed as your selected number on the rotating dial passes the datum line.
 - 4.8.12. When the tool reaches the end of the thread, disengage the automatic feed but DO NOT switch off the lathe.
 - 4.8.13. Reposition the tool for the second cut and engage the automatic feed again as your selected number on the rotating dial passes the datum line. Repeat until the thread is finished.

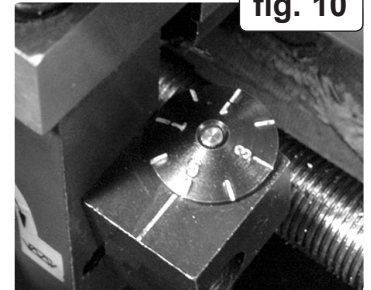

5. MAINTENANCE

- WARNING!** Ensure that the lathe is unplugged from the power supply before attempting any maintenance.
- 5.1. Lubricate the leadscrew bearings before each use (remove the end cover to access the left-hand bearing).
Lubricate the leadscrew thread before each use.
Lubricate the cross slide before each use (oil hole between hex. socket screws).
 - 5.2. Clean the machine after each use and oil all machined surfaces.
 - 5.3. The motor brushes may be inspected/replaced via screw caps which are accessed through holes, one in the front and one in the rear of the headstock base.
 - 5.4. If any play becomes apparent in either of the slides adjust as follows:
 - a) Loosen the lock nuts of the three gib strip adjusting screws (fig. 6.D shows the screws for the compound slide. Those for the cross slide are on the right-hand side of the slide).
 - b) Lightly tighten all three screws equally and check that the slide will not move with normal effort on the handle.
 - c) Back-off each screw by 1/4 turn and tighten the lock nuts.
 - d) Check that there is no play and that the slide moves smoothly.
 - e) If further adjustment is required, tighten or loosen the three screws as necessary by 1/8th of a turn only and recheck.

NOTE: It is our policy to continually improve products and as such we reserve the right to alter data, specifications and component parts without prior notice.

IMPORTANT: No liability is accepted for incorrect use of this product.

WARRANTY: Guarantee is 12 months from purchase date, proof of which will be required for any claim.

INFORMATION: For a copy of our latest catalogue and promotions call us on 01284 757525 and leave your full name and address, including postcode.



Sole UK Distributor, Sealey Group,
Kempson Way, Suffolk Business Park,
Bury St. Edmunds, Suffolk,
IP32 7AR

01284 757500
01284 703534

www.sealey.co.uk
sales@sealey.co.uk