

SUPERBOOST 140.V3	SUPERBOOST 160.V4	SUPERBOOST 180.V4	SUPERBOOST 200.V3
-------------------	-------------------	-------------------	-------------------

Thank you for purchasing a Sealey product. Manufactured to a high standard this item will give you years of trouble free performance if these instructions are carefully followed and the product is correctly maintained.



IMPORTANT: PLEASE READ THESE INSTRUCTIONS CAREFULLY. NOTE THE SAFE OPERATIONAL REQUIREMENTS, WARNINGS AND CAUTIONS. USE THIS PRODUCT CORRECTLY AND WITH CARE FOR THE PURPOSE FOR WHICH IT IS INTENDED. FAILURE TO DO SO MAY CAUSE DAMAGE AND/OR PERSONAL INJURY AND WILL INVALIDATE THE WARRANTY. PLEASE RETAIN THESE INSTRUCTIONS FOR FUTURE USE.

1. SAFETY INSTRUCTIONS

1.1. IMPORTANT: Small battery chargers are supplied with plugs fitted. Boost chargers and starter/chargers however can draw more than 13 amps from the mains supply whilst cranking large engines. For this reason, boost chargers are not supplied with plugs fitted. We recommend that for maximum performance your boost charger is plugged into a 30 amp supply and we further recommend that you consult an electrician in order to fit an appropriate plug.

The following Electrical Safety Section must also be read and understood when using this equipment.

1.2. ELECTRICAL SAFETY

WARNING! It is the responsibility of the owner and the operator to read, understand and comply with the following:

You must check all electrical products, before use, to ensure that they are safe. You must inspect power cables, plugs, sockets and any other connectors for wear or damage. You must ensure that the risk of electric shock is minimised by the installation of appropriate safety devices. A Residual Current Circuit Breaker (RCCB) should be incorporated in the main distribution board. We also recommend that a Residual Current Device (RCD) is used. It is particularly important to use an RCD with portable products that are plugged into a supply which is not protected by an RCCB. If in any doubt consult a qualified electrician. You may obtain a Residual Current Device by contacting your Sealey dealer. **You must** also read and understand the following instructions concerning electrical safety.

1.2.1. The **Electricity at Work Act 1989** requires that all portable electrical appliances, if used on business premises, are tested by a qualified electrician, using a Portable Appliance Tester (PAT), at least once a year.

1.2.2. The **Health & Safety at Work Act 1974** makes owners of electrical appliances responsible for the safe condition of those appliances and the safety of the appliance operators. **If in any doubt about electrical safety, contact a qualified electrician.**

1.2.3. Ensure that the insulation on all cables and on the appliance is safe before connecting it to the power supply. See 1.1.1. and 1.1.2. and use a Portable Appliance Tester.

1.2.4. Ensure that cables are always protected against short circuit and overload.

1.2.5. Regularly inspect power supply cables and plugs for wear or damage and check all connections to ensure that none is loose.

1.2.6. **Important:** Ensure that the voltage marked on the appliance matches the power supply to be used and that the plug is fitted with the correct fuse - see fuse rating at right.

1.2.7. **DO NOT** pull or carry the appliance by the power cable.

1.2.8. **DO NOT** pull the plug from the socket by the cable.

1.2.9. **DO NOT** use worn or damaged cables, plugs or connectors. Immediately have any faulty item repaired or replaced by a qualified electrician. When a BS 1363/A UK 3 pin plug is damaged, cut the cable just above the plug and **dispose of the plug safely**. Fit a new plug according to the following instructions (UK only) and see right.

Subject to 1.1. above, the following details the fitting of a 13 amp plug since a 13 amp supply will be adequate when charging and when starting small engines. No responsibility is accepted in the event that the product is misused and/or used on a 13 amp supply when a 30 amp supply is required.

a) Connect the **GREEN/YELLOW** earth wire to the earth terminal 'E'.

b) Connect the **BROWN** live wire to the live terminal 'L'.

c) Connect the **BLUE** neutral wire to the neutral terminal 'N'.

d) **After wiring, check that there are no bare wires, that all wires have been correctly connected, that the cable outer insulation extends beyond the cable restraint and that the restraint is tight.**

Double insulated products, which are always marked with this symbol , are fitted with live (brown) and neutral (blue) wires only. To rewire, connect the wires as indicated above - **DO NOT** connect either wire to the earth terminal.

1.2.10. Products which require more than 13 amps are supplied without a plug. In this case you must contact a qualified electrician to ensure that a suitably rated supply is available. We recommend that you discuss the installation of an industrial round pin plug and socket with your electrician.

1.2.11. If an extension reel is used it should be fully unwound before connection. A reel with an RCD fitted is preferred since any appliance plugged into it will be protected. The cable core section is important and should be at least 1.5mm², but to be absolutely sure that the capacity of the reel is suitable for this product and for others which may be used in the other output sockets, we recommend the use of 2.5mm² section cable.

1.3. GENERAL SAFETY

WARNING! Disconnect the charger from the mains power before servicing or performing any maintenance.

✓ Disconnect the charger from the mains power before connecting to, or disconnecting from, the battery.

✓ Maintain the charger in good condition (use an authorised service agent only).

WARNING! Charger has components such as switches and relays which may cause sparks or arcs. When using the charger in a garage or workshop, make sure it is in a safe location.

✓ Keep the charger clean for best and safest performance.

WARNING! Ensure that there are no sources of flammable ignition near the work area i.e. naked flames, cigarettes, flame heaters, etc., as the charging process produces explosive gases.

WARNING! Ensure that the work area is well ventilated as the gases produced are flammable.

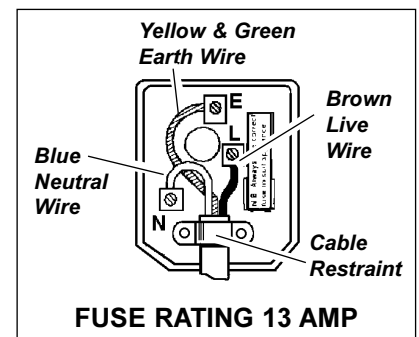

- ✓ Locate the charger in a suitable work area and keep the area clean and tidy and free from unrelated materials. Ensure there is adequate lighting.
- ✓ Wear approved safety eye protection (standard spectacles are not adequate).
- ✓ Remove ill fitting clothing. Remove ties, watches, rings and other loose jewellery and contain long hair.
- ✓ Read the vehicle handbook to check for any specific battery charging information.
- ✓ Disconnect the battery from the vehicle and move it to a safe, dry, level area for charging. If the battery can not be removed from the vehicle refer to manufacturer's handbook.
- ✓ Check the electrolyte fluid level in the battery is above the plates. If not, add distilled water to cover them by 5-10mm. DO NOT touch the battery fluid as it is corrosive.
- ✓ Clean the charger clamps and battery terminals, removing any oxidation before connecting the charger to the battery.
- ✓ Ensure that the correct polarity clamp is attached to the correct terminal of the battery. POSITIVE is indicated by (+) and may be red, NEGATIVE is indicated by (-) and may be black.
If there are no identifiable symbols, you can distinguish the NEGATIVE battery terminal as the one which is connected from the battery directly to the vehicle body.
- ✓ Remove the battery electrolyte cover or caps to allow the gases produced by charging to escape.
- ✓ Keep children and unauthorised persons away from the work area.
- x DO NOT attempt to charge a non-rechargeable battery.
- x DO NOT use the charger for any purpose other than that for which it is designed.
- x DO NOT allow untrained persons to operate the charger.
- x DO NOT allow the charger terminal clamps to touch each other when the power is on or the charger fuse will blow. Remember that gases are produced which may ignite if sparks occur.
- x DO NOT place the charger inside the vehicle. Remove the battery to a safe distance for charging.
- x DO NOT get the charger wet or use in damp or wet locations or areas where there is condensation.
- x DO NOT operate the charger if it is damaged.
- x DO NOT attempt to open or modify the charger.
- ✓ When not in use, unplug from the mains power supply and store in a safe, dry, child proof area.
- ❑ **WARNING!** Be vigilant and cautious during battery charging as the electrolyte is highly corrosive and the gases emitted are flammable and harmful to health.



2. SPECIFICATIONS

SUPERBOOST MODEL	140.V3	160.V4	180.V4	200.V3
Output	.12V	.12V/24V	.12V/24V	.12V/24V
12V Charge Peak (EN)	.21A (14A)	.40A (20A)	.40A (20A)	.45A (30A)
24V Charge Peak (EN)		.40A (20A)	.40A (20A)	.45A (30A)
12V Start Peak (EN)	.140A (80A)	.160A (110A)	.180A (120A)	.200A (180A)
24V Start Peak (EN)		.160A (110A)	.180A (120A)	.200A (180A)
Input, Charging	.2.5A	.2.5A	.4.5A	.4.5A
Input, Starting	.4.5A	.10A	.15A	.19A
Fuse Ref.	.120/802309 10pcs	.120/802260 20pcs	.120/802260 20pcs	.120/802259 20pcs

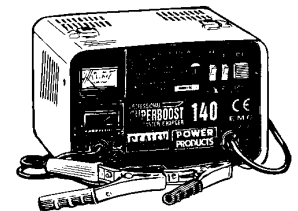

3. CHARGING INSTRUCTIONS

3.1. Preparation

It is important to correctly prepare for charging, ensuring that you follow Section 1 safety regulations carefully. Check that the capacity of the battery is compatible with the charger output.

- 3.1.1. Follow any vehicle manufacturer's instructions regarding battery charging. Note special instructions for in-vehicle charging.
- 3.1.2. Check the battery to ensure that the NEGATIVE and POSITIVE terminals are clearly identifiable before removing the battery from the vehicle.
- 3.1.3. Subject to 3.1.1. above, disconnect and remove the battery from the vehicle and place in an appropriate safe area ready for charging.
- 3.1.4. Remove the battery electrolyte cover or caps to allow the gases produced by charging to escape.
- 3.1.5. Check that the electrolyte is covering the plates inside. If not, add distilled water so that the plates are covered by 5-10mm.
- 3.1.6. The correct charging status of the battery may be determined by use of a hydrometer which will measure the specific gravity of the electrolyte. The following figures (kg/ltr) apply at 20°C: **1.28 = Fully charged, 1.21 = Half charged, 1.14 = Fully discharged.**

❑ **WARNING!** Be cautious and vigilant as the electrolyte is a highly corrosive acid.



3.2. Connecting the charger to the battery

Ensure that the battery charger is unplugged from the mains power supply before connecting the clamps to the battery.

- 3.2.1. For chargers with dual voltage output set the charger voltage to match that of the battery voltage (i.e. 12 or 24 volts) by connecting the positive (red) clamp lead to either the 12 volt output terminal or the 24 volt output terminal as appropriate.
- 3.2.2. Set the mode switch to "Charge", indicated by the battery symbol.
- 3.2.3. Set the rate of charge to that required by using the charge level switches as shown in fig. 1 or fig. 2. Please note that on the Superboost 200 the MIN & MAX switch relates to charge levels only. When the charge level is set to MAX the switch marked 1 & 2 is over-riden.
- 3.2.4. Check that the charger clamps and battery terminals are clean and free from oxidation.
- 3.2.5. Connect the POSITIVE (Red or +) lead to the POSITIVE (+) terminal on the battery and the NEGATIVE (Black or -) lead to the NEGATIVE (-) terminal

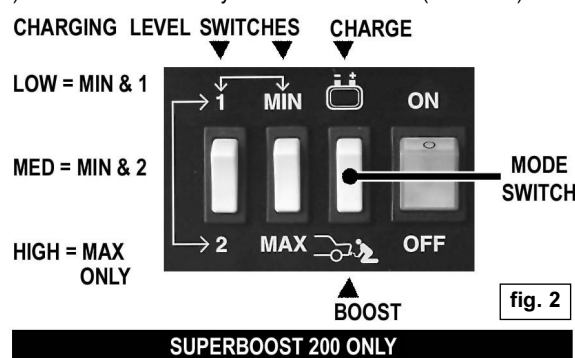
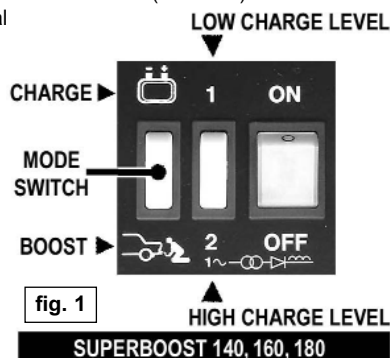

3.3. Charging the battery

- 3.3.1. Connect the charger to the mains power supply and switch on.
- 3.3.2. Check the current delivery to the battery by reading the ammeter on the front of the battery charger. During charging the pointer on the ammeter will slowly decrease (move to the left) according to the capacity and condition of the battery (see fig. 3, dial face may vary according to model of charger).
- 3.3.3. When the battery is fully charged the reading on the ammeter should be at the "0" output indicator. At this point the electrolyte in the battery will begin to bubble. Stop charging at this point in order to protect the battery plates from oxidation and to keep the battery in good condition.
- 3.3.4. Switch the charger off and unplug from the mains power supply. Disconnect the power clamps, clean and store the charger in a safe, dry area.
- 3.3.5. Replace the battery electrolyte cover or caps. Wipe up any splashes or spillage (remember that the electrolyte is a corrosive acid). Return the battery to the vehicle and secure according to the manufacturer's instructions. Reconnect the power leads. Check to ensure all tools etc. are removed before closing the bonnet or boot.

fig. 3

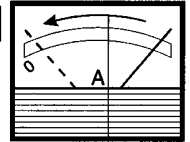

3.4. LOW or NO MAINTENANCE batteries

- 3.4.1. When charging a low, or no maintenance battery take very special care to use only a "LOW" charge setting. Use a battery tester to continually check the voltage across the clamps. When 14.4 volts is reached stop the charging process.

4. STARTING INSTRUCTIONS

Superboost chargers are combination units capable of both charging batteries and providing boost power to start vehicles with flat batteries. To charge a battery under normal circumstances refer to Section 3. To start a vehicle which has a flat battery follow the steps below.

- 4.1. Check the vehicle manufacturer's handbook and follow any special instructions and check that the battery is in good condition.
 - 4.2. Ensure the charger is disconnected from the power supply and set the mode switch (fig.1 or 2) to "Charge", indicated by the battery symbol.
 - 4.3. For chargers with dual voltage output set the charger voltage to match that of the battery voltage (i.e. 12 or 24 volts) by connecting the positive (red) clamp lead to either the 12 volt output terminal or the 24 volt output terminal as appropriate.
 - 4.4. Check the charger clamps and battery terminals to ensure they are clean and free from oxidation.
 - 4.5. Without removing the power leads that connect the battery to the vehicle, connect the Superboost POSITIVE (red) lead to the POSITIVE (+) battery terminal and the NEGATIVE (black) lead to NEGATIVE (-) battery terminal.
 - 4.6. Plug the charger into mains power supply and turn it on. Allow the battery to charge for 2-3 minutes.
 - 4.7. When the quick charge has been completed, change the mode switch from "Charge" to "Boost" (see fig. 1 or 2).
 - 4.8. Turn on the vehicle ignition and crank the engine for a MAXIMUM of 10 seconds.
- WARNING!** If the vehicle does not start within this time DO NOT continue as vehicle battery and electrical circuit may be damaged and the fuse in the charger will blow. If the vehicle fails to start, disconnect the charger and investigate.
- 4.9. When the engine is running, switch the Superboost off, unplug from the mains power and disconnect the clamps from the battery.

5. SIMULTANEOUS CHARGING

- 5.1. A number of batteries may be charged at the same time. To do so we recommend parallel connection as shown in fig.4A.
- 5.2. Two 12 volt batteries may be charged simultaneously in series using a 24 volt output charger as shown in fig.4B. This is only recommended if both batteries are of similar capacity and in a similar state of discharge.

6. SAFETY FUSE

The charger is equipped with a fuse which will protect the unit in the following circumstances:

- a) Overload: Too high a current to the battery.
- b) Short circuit: Clamps touch, or cross-connection to battery.
- c) Prolonged starting attempts.

If the fuse blows take the following action:

- 6.1. Turn the unit off and disconnect from the mains power supply.
- 6.2. Allow the unit to cool down, establish the reason for failure and correct the situation.
- 6.3. Replace the fuse (behind cover below ammeter), using only Sealey replacement parts.
DO NOT use a fuse with a copper bridge or similar as this will damage the equipment. Refer to Section 2 for fuse part numbers.

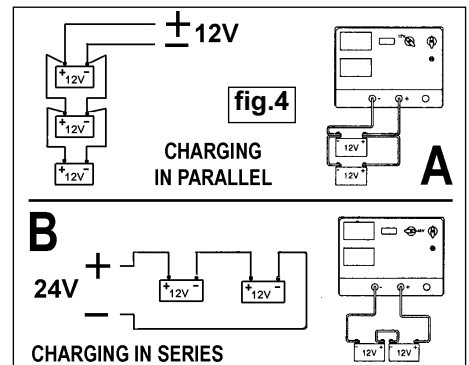

NOTE: It is our policy to continually improve products and as such we reserve the right to alter data, specifications and component parts without prior notice.

IMPORTANT: No liability is accepted for incorrect use of product.

WARRANTY: Guarantee is 12 months from purchase date, proof of which will be required for any claim.

INFORMATION: For a copy of our latest catalogue and promotions call us on 01284 757525 and leave your full name and address, including postcode.

SEALEY

POWER PRODUCTS

Sole UK Distributor,
Sealey Group,
Bury St. Edmunds, Suffolk.

01284 757500

01284 703534

e-mail sales@sealey.co.uk

www.sealey.co.uk



SUPERBOOST STARTER/CHARGERS

MODELS

SUPERBOOST 140.V3

SUPERBOOST 160.V4

SUPERBOOST 180.V4

SUPERBOOST 200.V3

DECLARATION OF CONFORMITY

We, the sole importer into the UK, declare that the products listed below are in conformity with the following standards and directives.

Superboost Starter/Chargers
Models 140.V3, 160.V4, 180.V4, 200.V3
73/23/EEC Low Voltage Directive
89/336/EEC EMC Directive
93/68/EEC CE Marking Directive

The construction files for these products are held by the Manufacturer and may be inspected, by a national authority, upon request to Jack Sealey Ltd.



Signed by Mark Sweetman
29th May 2003

For Jack Sealey Ltd. Sole importer
into the UK of Sealey Power Welders.

NOTE: It is our policy to continually improve products and as such we reserve the right to alter data, specifications and component parts without prior notice.

IMPORTANT: No liability is accepted for incorrect use of this equipment.

WARRANTY: Guarantee is 12 months from purchase date, proof of which will be required for any claim.

INFORMATION: For a copy of our latest catalogue and promotions call 01284 757525 and leave your full name and address, including postode.

SEALEY POWER PRODUCTS Sole UK Distributor,
Sealey Group,
Bury St. Edmunds, Suffolk.



01284 757500



01284 703534



sales@sealey.co.uk

Web www.sealey.co.uk